

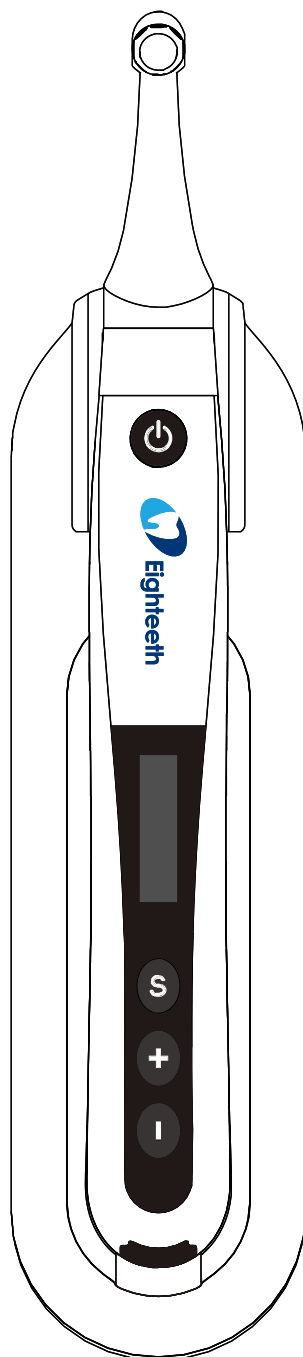

# E-xtreme



## Endo Motor USER MANUAL

Changzhou Sifary Medical Technology Co., Ltd.

Version: S02

IFU- 6035009/S02

Issued: Dec. 10 2020

Size: 160mm X 92mm

## Content

<b>1. Scope of E-xtreme</b>	<b>5</b>
1.1Parts Identification	5
1.2Components and Accessories	6
1.3 Options	6
<b>2. Symbols used in the User Manual</b>	<b>7</b>
<b>3. Before Use</b>	<b>9</b>
3.1Intended Use	9
3.2Contraindications	9
<b>4. Installing the E-xtreme</b>	<b>11</b>
4.1Installation of the contra angle	11
4.2Install the file	11
4.3Charging	12
4.4Install the Insulation Sleeve	13
<b>5. Use Interface</b>	<b>14</b>
5.1Panel key	14
5.2Screen display	15
5.3Terms and definition	16
<b>6. Setting</b>	<b>17</b>
6.1Set memory mode	17
6.2Set parameters	18
6.3Preset programs	21
6.4Advanced setting	23

6.5Parameter logic.....	26
<b>7. Operation.....</b>	<b>28</b>
7.1 Charge.....	28
7.2Motor Operation.....	30
<b>8. Cleaning, Disinfection and Sterilization.....</b>	<b>32</b>
8.1Foreword.....	32
8.2General recommendations.....	32
8.3Autoclavable Components.....	33
8.4Disinfection Components.....	38
<b>9. Error warnings.....</b>	<b>39</b>
<b>10. Troubleshooting.....</b>	<b>40</b>
<b>11. Technical Data.....</b>	<b>42</b>
<b>12. EMC Tables.....</b>	<b>44</b>
<b>13. Statement.....</b>	<b>51</b>

## 1. Scope of E-xtreme

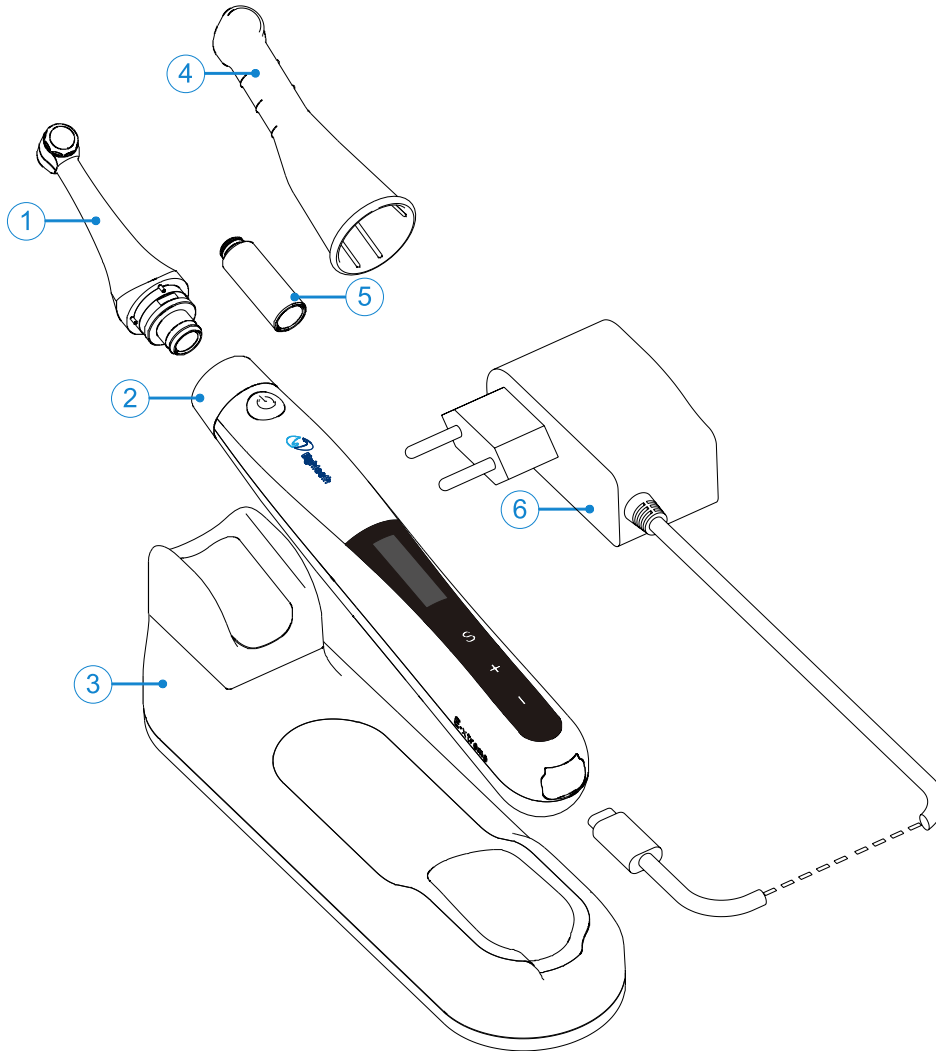

### 1.1 Parts Identification



1. Contra Angle
2. Motor Handpiece
3. Handpiece Base
4. Insulating Sleeve (optional)
5. Spray Nozzle
6. Adapter

Note: This product does not contain root canal file

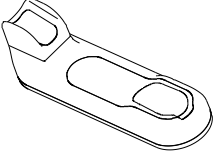
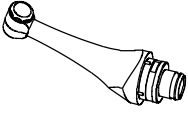
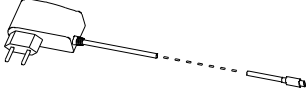















## 1.2 Components and Accessories

<p>Motor Handpiece (1pcs)</p> 	<p>Handpiece Base (1pcs)</p> 	<p>Contra Angle (1pcs)</p> 
<p>Adapter (1pcs)</p> 	<p>Spray Nozzle (1pcs)</p> 	<p>USER MANUAL (1pcs)</p>
<p>Certificate (1pcs)</p>	<p>Warranty card (1pcs)</p>	





## 1.3 Options

<p>Insulating Sleeve</p> 		
--	--	--

## 2. Symbols used in the User Manual

 <b>WARNING</b>	<p>If the instructions are not followed properly, operation may lead to hazards for the product or the user/patient.</p>
 <b>NOTE</b>	<p>Additional information, explanation of operation and performance.</p>
	<p>Serial number</p>
	<p>Catalogue number</p>
	<p>Manufacturer</p>
	<p>Date of manufacture</p>
	<p>Batch number</p>
	<p>Safety class II device</p>
	<p>Type B applied part</p>
	<p>CE marking</p>
	<p>Direct current</p>
	<p>Dispose of in accordance with the WEEE directive</p>
	<p>Keep dry</p>
	<p>Sterilizable in a steam sterilizer (autoclave) at the temperature specified</p>
	<p>Authorized Representative in the European Community</p>
	<p>Temperature limitation</p>
	<p>Relative humidity limitation</p>

## 2 Symbols used in the User Manual

 <p>106kPa 70kPa</p>	Atmospheric pressure limitation
	Manufacturer's LOGO
	Consult instructions for use
	Be careful! Refer to relevant documents
	Washer-disinfector for thermal disinfection



## 3. Before Use

### 3.1 Intended Use

Use for dental root canal treatment using endodontic instruments in torque controlled continuous rotation and in reciprocating movement.

This device must only be used in hospital environments, clinics or dental offices by qualified dental personnel and not used in the oxygen-rich environment.

### 3.2 Contraindications

The E-xtreme is contraindicated in cases where patient/user carry medical implants such as pace makers or cochlear implants etc.

Do not use the device for implants or other non-endodontic dental procedures.

Safety and effectiveness have not been established in pregnant women and children.



#### **WARNING**

Read the following warnings before use:

1. The device must not be placed in humid surroundings or anywhere where it can come into contact with any type of liquids.
2. Do not expose the device to direct or indirect heat sources. The device must be operated and stored in a safe environment.
3. Do not use the equipment in the presence of free oxygen, anesthetic gas or combustible materials. The equipment must be operated, used and stored in a safe environment.
4. The device requires special precautions with regard to electromagnetic compatibility (EMC) and must be installed and operated in strict compliance with the EMC information. In particular, do not use the device in the vicinity of fluorescent lamps, radio transmitters, remote controls and do not use this system near the active HF Surgical Equipment in the hospital. Portable RF communications equipment (including peripherals such as antenna cables and external antennas) should be used no closer than 30 cm (12 inches) to any part of the E-xtreme, including cables specified by the manufacturer. Otherwise, degradation of the performance of this equipment could result.
5. Please do not charge, use or store this equipment at high temperature. Please pay attention to the use and storage conditions.

6. Gloves and a rubber dam are compulsory during treatment.
7. Never open or repair the device yourself, otherwise, void the warranty.
8. If irregularities occur in the device during treatment, switch it off. Contact the agency.
9. Please use the original power adapter when charging; do not use the equipment for treatment during charging.
10. If liquid flows out of the handpiece, it can be judged as battery leakage. Please stop using immediately and contact the local dealer for treatment.
11. Do not dismount the contra angle during the operation of the main engine, otherwise the contra angle and motor gear will be damaged.
12. Please use the original contra angle.
13. Use continuous file in continuous mode; use reciprocating file in reciprocating mode, and use according to rotation speed, torque and return angle recommended by the root canal file manufacturer.

## 4. Installing the E-xtreme

### 4.1 Installation of the contra angle

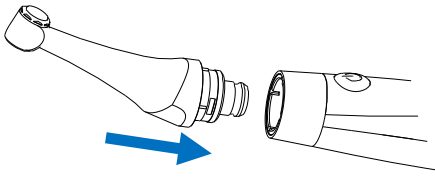
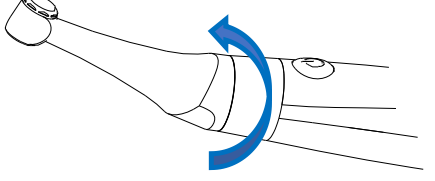
	<p>Make sure 4 pins on contra angle alignment the slots of handpiece, plug them together until it “click” securely into place.</p>
	<p>The contra angle can be 360 degrees rotated without take off, make it easy to watch the LCD in treatment by rotating the contra angle.</p>



**WARNING**

1. Make sure the assembly is connected properly, otherwise might cause unexpected motor reverse, even hurt the patients
2. After connecting the contra angle and handpiece, pull it gently to make sure the connection is good.

### 4.2 Install the file

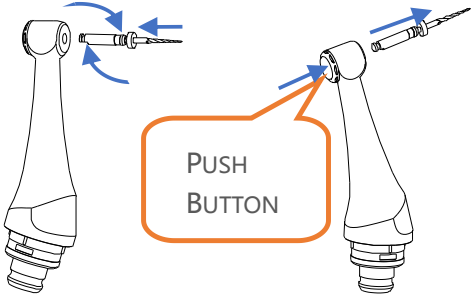
 <p style="text-align: center;">Install                      Remove</p>	<p><b>Install:</b> insert the root canal file and rotate it slightly from left to right to ensure that the file needle is aligned with the internal bayonet, and then push it in slightly to complete the installation.</p> <p><b>Remove:</b> press and hold the back cover button on the contra angle to release the internal bayonet and gently pull out the root canal file.</p>
--	---



## 4 Installing the E-xtreme



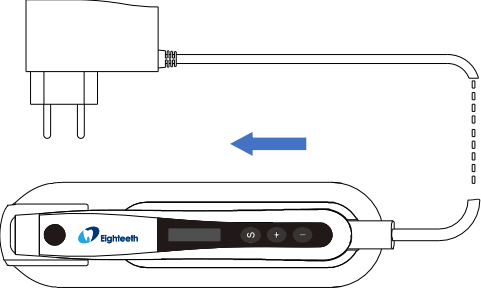

### **WARNING**

1. Inspect the file head before inserting the file. Do not use the damaged file head.
2. Be careful when inserting and removing files to avoid injury to fingers.
3. Pull the file gently to make sure that the file is secure in hand-piece properly, otherwise it may pop out and hurt the patient.
4. When removing the file, press the button tightly to release the internal bayonet. If the bayonet is not fully released, the bearing will be damaged.
5. Make sure the motor is stopped when inserting and removing files.

### 4.3 Charging

	<p>Show the remaining power. This icon indicates that the remaining power is less than 15%, please charge it in time.</p>
	<p>Connect the power adapter to E-xtreme as shown.</p>
<p> <b>WARNING</b></p> <p>Only the original adapter could be used.</p>	
	<p>When the power adapter is connected to E-xtreme, the screen will display the figure on the left, which indicates charging.</p>

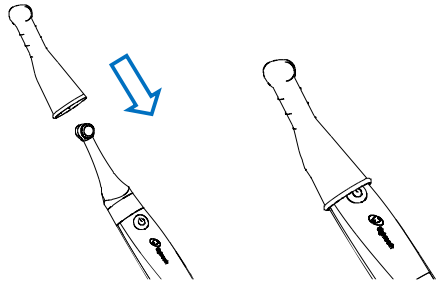
#### 4.4 Install the Insulation Sleeve

	<p><b>Install:</b> assemble according to the left figure</p> <p><b>Remove:</b> pull out the cover in the opposite direction</p> <p> <b>NOTE</b></p> <p>The insulating sleeve is mainly used for secondary isolation to avoid cross infection.</p>
---	--

## 5. Use Interface

### 5.1 Panel key

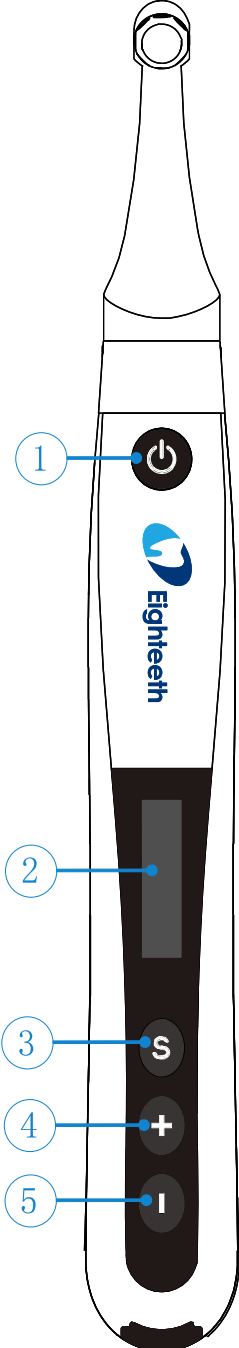

①  Main switch

② Display screen

③  Setting key



④  Increase key

⑤  Decrease key





**Power on**

Press  more than 0.5 seconds to turn on the instrument.





**Memory Change**

Press  or  to change at standby mode.





**Operation Mode Change**

Press  once at standby mode, press  or  to switch, then press  or wait 5 seconds to confirm.



**Parameter Adjustment**

Press  till target parameters are displayed at standby mode, press  or  to adjust, then press  or wait 5 seconds to confirm.







**Preset Program Selection**

Long press  at standby mode to enter preset program, press  or  to select deserve program and press  to confirm.

**Power off**

Holding  and press 

**Advanced Setting**

Holding  then press  to enter advanced setting at power off mode, press  till target parameters are displayed, press  or  to adjust the parameters, then press  to confirm.

## 5.2 Screen display

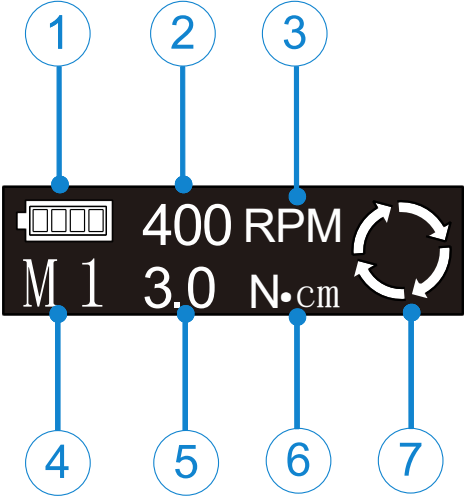
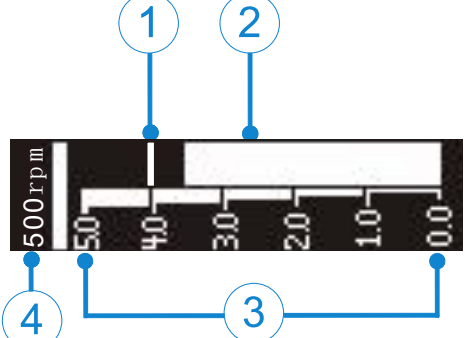
 <p>The standby interface screen shows a battery icon with four segments, a speed of 400 RPM, a memory mode number M 1, a torque of 3.0 N·cm, and a circular arrow icon. Seven callout lines point to specific elements: 1 (battery), 2 (speed), 3 (unit of speed), 4 (memory mode number), 5 (torque), 6 (unit of torque), and 7 (circular arrow icon).</p>	<p><b>Standby interface</b></p> <ul style="list-style-type: none"> <li>① Residual battery power</li> <li>② Speed</li> <li>③ Unit of speed (Revolutions Per Minute)</li> <li>④ Memory mode number</li> <li>⑤ Torque</li> <li>⑥ Unit of torque (Newton Centimeter)</li> <li>⑦ Operation mode</li> </ul>
 <p>The working mode interface screen shows a torque display scale from 0.0 to 5.0 with a 500 rpm marker. A horizontal bar indicates the current torque level. Four callout lines point to: 1 (set maximum torque), 2 (real torque), 3 (torque display scale), and 4 (preset speed).</p>	<p><b>Working mode interface</b></p> <ul style="list-style-type: none"> <li>① The set maximum torque</li> <li>② Real torque</li> <li>③ Torque display scale</li> <li>④ The preset speed</li> </ul>

### 5.3 Terms and definition

Fwd/Fw	Forward ( Clockwise rotation )
Rev/Rv	Reverse ( Counter clockwise rotation )
REC	Reciprocation: Be applied to reciprocating file, path file and rotary file protection by setting some special angle
Memory mode	Such as M0-M9
Operation mode	Such as Fwd, Rev (set in M1-M9), Reciprocation (M0)
TRQ	Torque
MEM	Memory
R·D	Rotate Direction
DIR	Direction
Separation of instruments	The file used in root canal therapy is broken accidentally.



## 6. Setting

### 6.1 Set memory mode

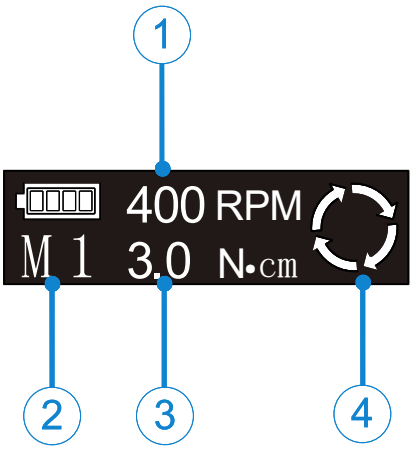
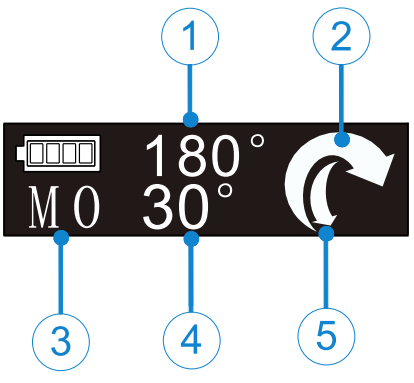
 <p>The LCD display for memory mode M1 shows a battery icon, the text 'M 1', '400 RPM', '3.0 N.cm', and a circular arrow icon. Callouts 1, 2, 3, and 4 point to the speed, memory number, torque, and operation mode icon respectively.</p>	<p>The device has 10 memory modes (M0-M9), press <b>+</b> or <b>-</b> at standby mode, memory number (2) will change accordingly.</p> <p>Each memory mode includes its own speed (1), operation mode (4) and torque (3). These parameters can be set separately. <b>(Adjust parameters according to chapter 6.2).</b></p>
 <p>The LCD display for memory mode M0 shows a battery icon, the text 'M 0', '180°', '30°', and a curved arrow icon. Callouts 1, 2, 3, 4, and 5 point to the forward angle, reverse angle, memory number, torque, and operation mode icon respectively.</p>	<p>M0 is a separate mode of reciprocating mode. Including forward angle(1) and reverse angle (4). These parameter can be set separately. <b>(Adjust parameters according to chapter 6.2).</b></p> <p>Figure(2)means Forward, and figure(5)means Reverse. The bigger figure means angle of this direction is bigger than the other one.</p>

## 6.2 Set parameters



**WARNING**

All parameters must be set according to the recommended values of root canal file manufacturer. Before starting the device for operation, make sure that all parameters are correct, otherwise there is a risk of instrument separation.

	<p>Before starting the motor, check whether the operation mode (①) is correct. If it is not the expected operation mode, press <b>S</b> once on the standby mode to enter the operation mode selection, press <b>+</b> or <b>-</b> to switch, and then press <b>•</b> or wait for 5 seconds to confirm the operation mode.</p>
	<p>The left figure describes the setting of common functions of the device (memory mode M1 to M9 are applicable). In standby mode (①) press <b>S</b> to enter the speed setting, press <b>+</b> or <b>-</b> to set the speed value; after the speed value is set, press <b>S</b> again to enter the torque setting, press <b>+</b> or <b>-</b> to set the torque value. After the torque value is set, press <b>S</b> again to enter the rotation direction operation mode (two modes: Fwd and Rev), press <b>+</b> or <b>-</b> to set, then press <b>•</b> or <b>S</b> or wait for 5 seconds to confirm the operation mode.</p>



NOTE

In different operation modes, the values of parameters will be different according to the corresponding logic (**Adjust parameters according to chapter 7.2**).

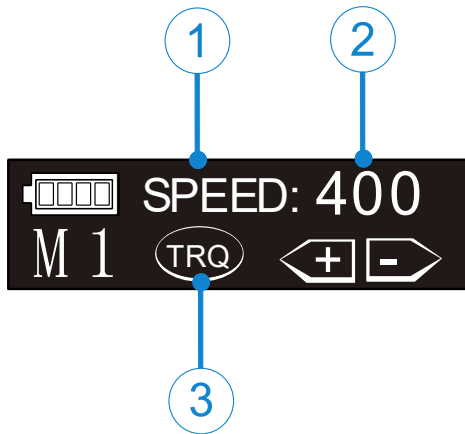

In M1-M9 memory mode, the speed can be 120rpm-650rpm. Press **S** at standby mode till speed (①②) is displayed, press **+** or **-** to set, then press **•** or wait for 5 seconds to confirm. The left figure (③) means after pressing **S** again will enter torque (TRQ) setting.

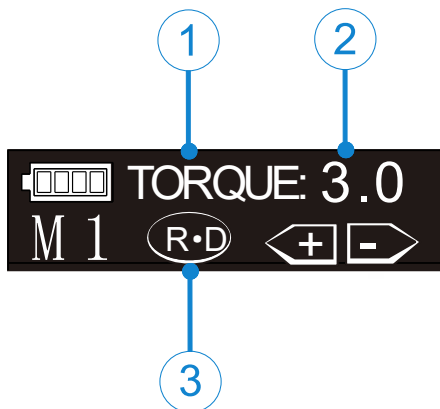

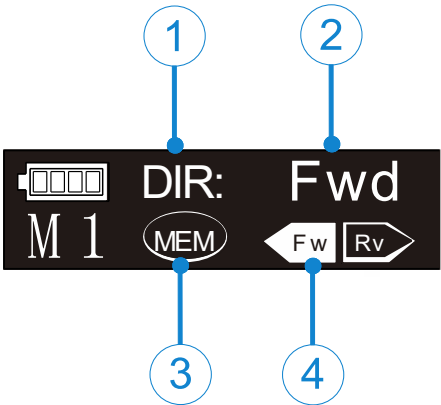
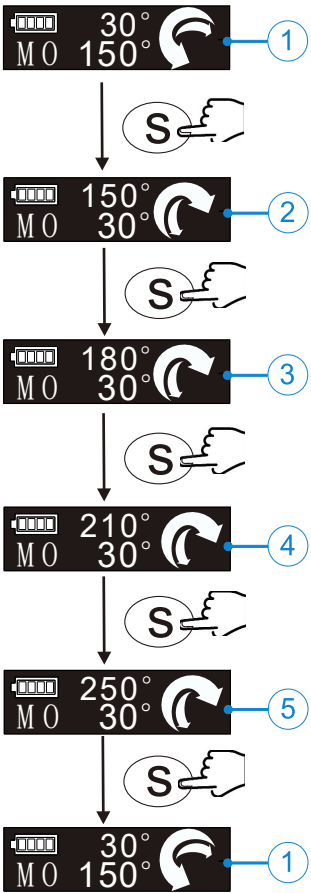

The torque value can be set from 0.5 to 4.0 N·cm. Press **S** at standby mode till torque (①②) is displayed, press **+** or **-** to set, then press **•** or wait for 5 seconds to confirm. The left figure (③) means after pressing **S** again will enter rotate direction (R.D.) setting mode.

	<p>Fwd or Rev can be set in operation mode of M1-M9. Press <b>S</b> till the operation mode (①②④) is displayed, press <b>+</b> or <b>-</b> to set, then press <b>•</b> or wait 5 seconds to confirm. The left figure(③) means press <b>S</b> again will enter memory mode (MEM).</p> <p><b>NOTE</b></p> <p>When Rev operation mode is selected, a continuous alarm sound will appear after the device is started to remind the operator that the motor is in reverse rotation.</p>
	<p>The left figure describes the setting of M0(REC mode): Press <b>S</b> at M0(①) to switch different reciprocating preset programs. There are altogether 5 sets of preset reciprocating programs.</p>

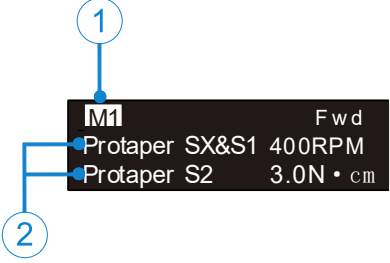
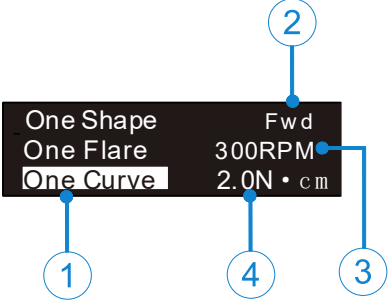
### 6.3 Preset programs

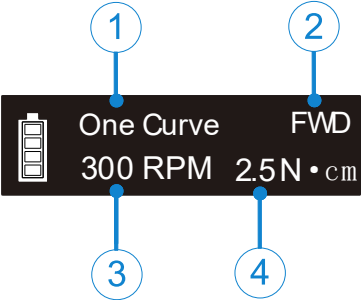
	<p>For the convenience of the operator, some common root canal file systems are preset.</p> <p>Long press <b>S</b> at standby mode to enter preset mode, the screen will display as the figure shows on the left.</p> <p>M1(①) means current memory mode, operator can choose preset mode(②) to replace it. Press <b>+</b> or <b>-</b> to switch (press the key several times to jump to the next page). Then press <b>•</b> to confirm.</p>
	<p>If you select one of the preset programs, such as "one curve" (①), the corresponding operation mode(②), speed(③) and torque(④) will be automatically set.</p> <p><b>NOTE</b></p> <p>Protaper<sup>®</sup>, GATES<sup>®</sup>, Pro.Glider<sup>®</sup>, and Wave one<sup>®</sup> is a registered trademark of Dentsply.</p> <p>Mtwo<sup>®</sup>, Flex.Master<sup>®</sup>, Reciproc<sup>®</sup> and R-Pilot<sup>®</sup> is a registered trademark of VDW.</p> <p>K3XF<sup>®</sup>, TF<sup>®</sup> is a registered trademark of SybronEndo.</p> <p>OneG<sup>®</sup>, OneShape, OneFlare, 2Shape and OneCurve<sup>®</sup> is a registered trademark of Micro-Mega</p> <p>XPendo.Shaper<sup>®</sup>, XPendo.Finisher<sup>®</sup>, Irace<sup>®</sup>, BT-Race<sup>®</sup> and BioRace<sup>®</sup> is a registered trademark of FKG</p>

	<p>When the preset mode is selected, the memory number(①) will be changed to the preset name, operation mode (②), speed (③) and torque (④) will also be automatically set.</p> <p> <b>NOTE</b></p> <p>All memory modes (from M1 to M9) can be replaced by preset programs in this way.</p>
---	---

## 6.4 Advanced setting

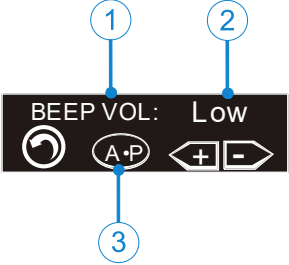
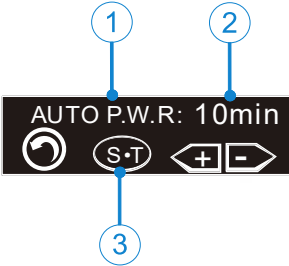
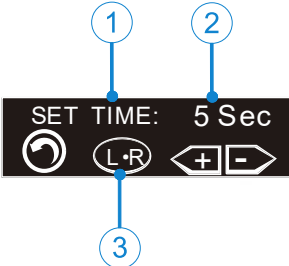
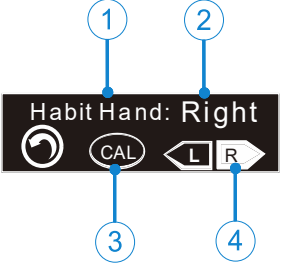
	<p>Hold <b>S</b> then press <b>•</b> (for about 0.5 seconds) at off mode to enter advanced set mode.</p>
	<p>It will be about 1 second at SET logo and then enter ① "BEEP VOL" (beep volume set). Press <b>+</b> or <b>-</b> to set ② (Mute, Low, Mid, High), then press <b>•</b> to confirm and shut down. The left figure ③ means press <b>S</b> once in this case will enter auto power off time set (A.P).</p>
	<p>Press <b>S</b> again at beep volume set ① will enter " AUTO P.W.R" (auto power off time set), press <b>+</b> or <b>-</b> to set ② (3-15 minutes), then press <b>•</b> to confirm and shut down. The left figure ③ means press <b>S</b> again will enter auto set confirm time (S.T).</p>
	<p>Press <b>S</b> again at auto power off time set ① will enter " SET TIME " (auto set confirm time). Press <b>+</b> or <b>-</b> to set ② (3-15 seconds), then press <b>•</b> to confirm and shut down. The left figure ③ means press <b>S</b> again will enter hand habit set mode (L.R).</p>
	<p>Press <b>S</b> again at auto set confirm time ① will enter " Habit Hand" (hand habit set). Press <b>+</b> or <b>-</b> to set ②④ (Left, Right), then press <b>•</b> to confirm and shut down. The left figure ③ means press <b>S</b> again will enter auto calculation(CAL).</p> <p>After switching to the left-handed habit, the display interface will rotate 180 ° to facilitate the left-handed operator to observe the display screen.</p>

## 6 Setting

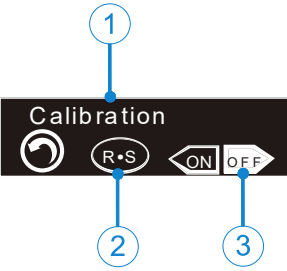
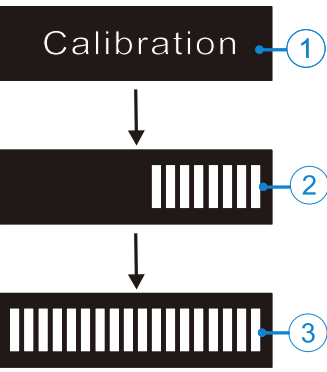
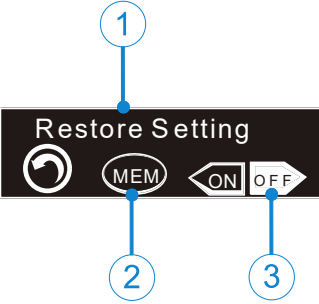
	<p>Press <b>S</b> again at hand habit set will enter ① “Calibration” auto calibration, press <b>+</b> or <b>-</b> to set ③(ON、OFF), Choose “ON” and press <b>•</b> or <b>S</b> to confirm and the device will auto calibrate. The left figure ② means when choose “OFF” and press <b>S</b> again will enter restore settings (R.S).</p>
	<p>When the device auto calibrate ①, the screen will display the progress ② (through the bar), after calibrating ③ the bar will be full and the device will beep out.</p> <p><b>NOTE</b></p> <p>Before automatic calibration, make sure that the original contra angle is installed on the handpiece, and the root canal file is not installed on the contra angle. If the contra angle is not installed or non-original contra angle is installed, the torque after calibration may be incorrect, which may bring the risk of instrument separation.</p>
	<p>Press <b>S</b> again at auto calibration with switch” off” will enter ① “Restore Setting (restore settings). Press <b>+</b> or <b>-</b> to set ③(ON、OFF). Choose “ON” and press <b>•</b> or <b>S</b> to confirm and restore all settings. Choose “OFF” and press <b>S</b> again ② (MEM) to confirm, save all settings above and return to the memory mode. All parameters will be covered by the factory default parameters. <b>(refer to chapter 7.5 parameter logic).</b></p> <p><b>NOTE</b></p> <p>After restoring the factory settings, the parameters set by the customer will be covered by the factory default</p>



## 6 Setting

	parameters. If necessary, please record the parameters before restoring the factory settings.
--	---

## 6.5 Parameter logic

The factory default parameters of the ten memory modes are shown in the table below. The parameters can be adjusted as needed.

The default advanced settings parameters are shown in the following table. The parameters can be adjusted as needed

Parameter	M0	M1	M2	M3	M4	M5	M6	M7	M8	M9
<b>Operation mode</b>	REC	Fwd	Fwd	Fwd	Fwd	Fwd	Rev	Rev	Fwd	Fwd
<b>Speed(rpm)</b>	N/A	350	300	400	400	300	350	500	500	650
<b>Torque(N·cm)</b>	N/A	2.5	3.0	2.0	1.5	1.5	2.5	2.0	2.5	2.0
<b>Fwd angle</b>	30	N/A	N/A	N/A	N/A	N/A	N/A	N/A	N/A	N/A
<b>Rev angle</b>	150	N/A	N/A	N/A	N/A	N/A	N/A	N/A	N/A	N/A

The default advanced settings parameters are shown in the following table. The parameters can be adjusted as needed.

<b>Volume</b> BEEP VOL	Mid
<b>Auto power off</b> AUTO P.W.R	10min
<b>Auto set confirm</b> SET TIME	5s
<b>Hand habit</b> Habit Hand	Right

<b>Auto calibrate</b> Calibration	Off
<b>Restore settings</b> Restore Setting	Off
/	/
/	/

The rotational speed (RPM) varies in different operating modes, as shown in the table below

Fwd		Rev			REC
120	150	200	250	280	/
300	350	400	450	500	
550	600	650			

Torque (N•cm) in different operation modes, the torque value can be set differently even in the same operation mode when the speed value is set differently. See the table below for details.





Fwd		Rev					REC		
0.5	0.8	1.0	1.5	1.8	2.0	2.2	2.5	3.0	/
3.2	3.5	4.0							



There are 5 fixed values of **reciprocating Angle** in M0 reciprocating mode, and the Angle cannot be changed., as shown in the table below.

<del> </del>	Fwd	Rev	REC
reciprocating Angle		/	Five sets of fixed values 1. Fwd angle 30°, Rev angle 150° 2. Fwd angle 150°, Rev angle 30° 3. Fwd angle 180°, Rev angle 30° 4. Fwd angle 210°, Rev angle 30° 5. Fwd angle 250°, Rev angle 30°

## 7.Operation

### 7.1 Charge

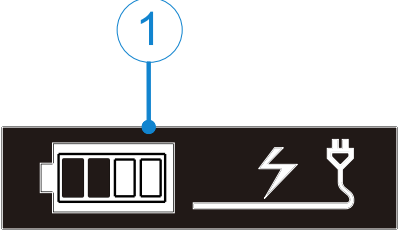
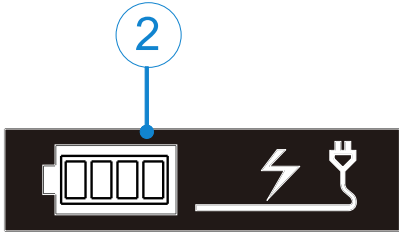
	<p>Display the remaining power. The remaining charge is less than 15%.</p>
	<p> <b>NOTE</b></p> <ol style="list-style-type: none"> <li>1. If the battery power is less than 15%, it must be recharged within 30 days, otherwise the battery will be irretrievably damaged due to low power.</li> <li>2. If you do not use this product for a long time, please charge the product at least once a month.</li> </ol>
	<p>If the battery power is lower than 15%, the speed and torque may be lower than the set value. As shown in the left figure, the low power alarm will appear on the display screen with continuous use, and the device will automatically shut down.</p>
	<p> <b>NOTE</b></p> <p>Because the display of the remaining power is based on the voltage level, if a large torque load appears during the operation, the remaining power display may appear a short-term decrease.</p>

 	<p>When charging, the charging indicator will appear on the display screen and flicker slowly (①). When the battery is fully charged or in the state of nearly full charge, the display will stop flashing, and the charging indication is shown in the figure (②).</p> <p>It takes about 4 hours to fully charge the battery. If the remaining charge of the battery is different or the state of the battery is different (such as aging), the charging time will be different.</p> <p>According to the use state of the battery, the battery can be recharged 300-500 times, and then the battery power will be significantly reduced.</p>
	<p> <b>WARNING</b></p> <p>It is forbidden to replace batteries by non professionals or trained personnel. If the wrong battery is used or installed incorrectly, the electronic components will be damaged.</p>

## 7.2 Motor Operation

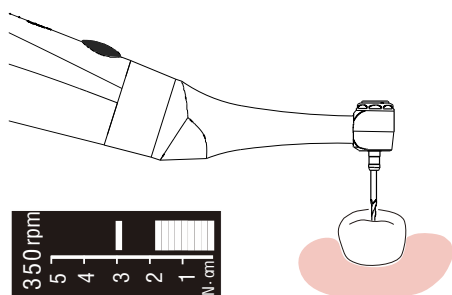

In the standby mode, the root canal preparation device is started by pressing the main switch . After startup, the progress bar will be displayed on the display screen (for details of the progress bar, please refer to chapter 5.2 display screen interface).



### WARNING

1. Before using in the treatment, please try it out of the mouth to ensure that the function of the device is normal.
2. The root canal file may be damaged suddenly when it enters into the root canal which is too curved or not in good shape. When the user feels that the root canal is abnormal, please stop using the device immediately and confirm the correct operation parameters and methods.
3. Even if the normal parameters are set, due to the metal fatigue of the root canal file, the instrument will be separated. Therefore, when using the root canal file, do not exceed the times recommended by the manufacturer, and replace it in time.
4. When the root canal file is subjected to excessive external force, it may break. When using this equipment, do not apply excessive external force to the root canal file.
5. Do not press the back cover of the contra angle during the treatment, otherwise the equipment will be damaged, and even the flying file will hurt the patient.
6. The electromagnetic noise in the surrounding environment may interfere with the normal operation of the equipment. Please do not completely rely on the automatic control of the equipment, and always pay attention to the feedback information on the LCD screen.



### *NOTE*

1. When there is any abnormality, please stop using the equipment. This equipment is not suitable for all types of root canals. It is recommended to use according to the instructions of root canal file.
2. The root canal file is easy to fracture at high speed. Please follow the rotation speed recommended by the manufacturer. Please check the set speed before use.
3. When using this equipment, use the root canal file with materials other than nickel titanium carefully.
4. Please use disposable gloves and rubber barrier for treatment.
5. After the treatment, please take out the root canal file to avoid damage to the root canal file.

## **8.Cleaning, Disinfection and Sterilization**

### **8.1 Foreword**

For hygiene and sanitary safety purpose, the components (contra angle, and insulating sleeve) must be cleaned, disinfected and sterilized before each usage to prevent any contamination. This concerns the first use as well as the subsequent uses. Comply with your national guidelines, standards and requirements for cleaning, disinfection and sterilization. Reprocessing procedures have only limited implications to this dental device. The limitation of the numbers of reprocessing procedures is therefore determined by the function / wear of the device. From the processing side there is no maximum number of allowable reprocessing. The device should no longer be reused in case of signs of material degradation.



In case of damage the device should be reprocessed before sending back to the manufacturer for repair.

### **8.2 General recommendations**

- The user is responsible for the sterility of the product for the first cycle and each further usage as well as for the usage of damaged or dirty instruments, where applicable after sterility.
- For your own safety, please wear personal protective equipment (gloves, safety glasses, etc.).
- Use only a disinfecting solution which is approved for its efficacy (VAH/DGHM-listing, CE marking, and FDA approval) and in accordance with the DFU of the disinfecting solution manufacturer.
- The water quality has to be convenient to the local regulations especially for the last rinsing step or with a washer-disinfector.
- Thoroughly clean and wash the components before autoclaving.
- Do not lubricate the motor handpiece.
- Do not clean the contra angle with an ultrasonic cleaning device.
- Do not use bleach or chloride disinfectant materials.



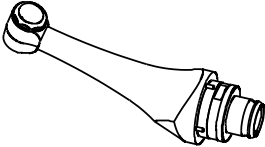
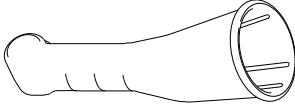



### 8.3 Autoclavable Components

Autoclavable Components	
Contra Angle 	Insulating Sleeve (optional) 
 <b>WARNING</b> 1. Only the components above can be autoclaved. 2. Before first use and after each use, sterilize the above components.	
<b>Reprocessing Instructions</b>	
<b>Preparation at the Point of Use</b>	Disconnect the components (Contra Angle, Insulating Sleeve) from the handpiece. Refer to "Chapter 4-Installing the E-xtreme" of this manual for disassembly instructions. Remove gross contaminations from the components with code water (<40°C) immediately after use. Don't use a fixating detergent or hot water (>40°C) as this can cause the fixation of residuals which may influence the result of the reprocessing process. Store the instruments in a humid surrounding.  <b>WARNING</b> Do not submerge the components or wipe them with any of the following functional water (acidic electrolyzed water, strong alkaline solution, or ozone water), medical agents (glutaral, etc.), or any other special types of water or commercial cleaning liquids. Such liquids may result in metal corrosion and adhesion of the residual medical agents to the components.
<b>Transportation</b>	Safe storage and transportation to the reprocess-

	<p>sing area to avoid any damage and contaminate on to the environment.</p>
<p><b>Preparation for Decontamination</b></p>	<p>The devices must be reprocessed in a disassembled state.</p> <p> <b>WARNING</b></p> <ol style="list-style-type: none"> <li>1. Do not fail to take out the file before cleaning the contra angle.</li> <li>2. Observe suitable personal protective measures.</li> </ol>
<p><b>Pre-Cleaning</b></p>	<p>Do a manual pre-cleaning, until the components are visually clean. Submerge the components in a cleaning solution and flush the lumens with a water jet pistol with cold tap water for at least 10 seconds. Clean the surfaces with a soft bristol brush.</p>
<p><b>Cleaning</b></p>	<p>Regarding cleaning/disinfection, rinsing and drying, it is to distinguish between manual and automated reprocessing methods. Preference is to be given to automated reprocessing methods, especially due to the better standardizing potential and industrial safety.</p> <p>Automated Cleaning: Carefully put the components into the washer-disinfector on a tray and set the parameters as follows, then start the program:</p> <ul style="list-style-type: none"> <li>• 4 min pre-washing with cold water (&lt;40°C);</li> <li>• emptying</li> <li>• 5 min washing with a mild alkaline cleaner at 55°C;</li> <li>• emptying</li> <li>• 3 min neutralising with warm water (&gt;40°C);</li> <li>• emptying</li> </ul>



	<ul style="list-style-type: none"> <li>• 5 min intermediate rinsing with warm water (&gt;40°C);</li> <li>• emptying</li> </ul> <p><i>The automated cleaning processes have been validated by using 0.5% neodisher MediClean forte (Dr. Weigert).</i></p> <p>Note Acc. to EN ISO 17664 no manual reprocessing methods are required for these devices. If a manual reprocessing method has to be used, please validate it prior to use.</p> <div style="background-color: #f0f0f0; padding: 5px;">  <p><b>WARNING</b></p> <ol style="list-style-type: none"> <li>1. Use only approved washer-disinfectors according to EN ISO 15883, maintain and calibrate it regularly.</li> <li>2. Follow instructions and observe concentrations given by the manufacturer (see general recommendations).</li> <li>3. Avoid any contact between the contra angle and any instrument, kit, support or container.</li> </ol> </div>
<p><b>Disinfection</b></p>	<p>Automated Thermal Disinfection in washer/disinfector under consideration of national requirements in regards to A0 value (see EN ISO 15883).</p> <p>A disinfection cycle of 5 min disinfection at 93°C has been validated for the device to achieve an A0 value of 3000.</p> <p>After manual cleaning, the instruments should be automated disinfected or sterilized immediately. A manual disinfection is not recommended.</p>
<p><b>Drying</b></p>	<p>Automated Drying: Drying of outside of instrument through drying cycle of washer/disinfector. If needed, additional manual drying can be performed through lint free towel. Insufflate cavities of instruments by</p>

	using sterile compressed air.
<b>Functional Testing, Maintenance</b>	<p>Visual inspection for cleanliness of the instruments and reassembling. Functional testing according to instructions of use. If necessary, perform reprocessing process again until instrument is visibly clean.</p> <p>Before packaging and autoclaving, make sure that the components have been maintained acc. to manufacturer' s instruction.</p> <p>Only the contra angle needs to be lubricated.</p> <div data-bbox="644 707 1198 981" data-label="Image"> </div> <div data-bbox="555 1003 1315 1400" data-label="Complex-Block" style="background-color: #e0e0e0; padding: 10px;"> <p> <b>WARNING</b></p> <ol style="list-style-type: none"> <li>1. Before autoclaving, the contra angle must be lubricated.</li> <li>2. Attaching the spray nozzle to oil can and contra angle, press the oil can button more than 3 seconds, till all the black oil flow out from the head of the contra angle.</li> </ol> </div>
<b>Packaging</b>	<p>Pack the instruments in an appropriate packaging material for sterilization.</p> <div data-bbox="555 1503 1315 1805" data-label="Complex-Block" style="background-color: #e0e0e0; padding: 10px;"> <p> <b>WARNING</b></p> <ol style="list-style-type: none"> <li>1. Check the validity period of pouch given by the manufacturer to determine the shelf life.</li> <li>2. Use pouches which resist to a temperature up to 141°C and in accordance with EN ISO 11607.</li> </ol> </div>
<b>Sterilization</b>	<p>Sterilization of instruments by applying a fractionated pre-vacuum steam sterilization process (according to EN 285/EN 13060/EN ISO 17665) under consideration of the respective country requirements.</p>

	<p>Minimum requirements: 3 min at 134 °C (in EU: 5 min at 134 °C)  Maximum sterilization temperature: 137°C  Flash sterilization is not allowed on lumen instruments!</p> <p> <b>WARNING</b></p> <ol style="list-style-type: none"> <li>1. Use only approved autoclave devices according to EN 13060 or EN 285.</li> <li>2. Use a validated sterilization procedure according to EN ISO 17665.</li> <li>3. Respect the maintenance procedure of the autoclave device given by the manufacturer.</li> <li>4. Use only this recommended sterilization procedure.</li> <li>5. Control the efficiency (packaging integrity, no humidity, color change of sterilization indicators, physicochemical integrators, digital records of cycles parameters).</li> <li>6. The sterilization procedure must comply with EN ISO 17665.</li> <li>7. Wait for cooling before touching.</li> </ol>
<b>Storage</b>	<p>Storage of sterilized instruments in a dry, clean and dust free environment at modest temperatures, refer to label and instructions for use.</p> <p> <b>WARNING</b></p> <ol style="list-style-type: none"> <li>1. Sterility cannot be guaranteed if packaging is open, damaged or wet.</li> <li>2. Check the packaging and the contra angle before using it (packaging integrity, no humidity and validity period).</li> </ol>
<p> <b>NOTE</b></p> <p>The instructions provided above have been validated by the manufacturer of the medical device as being capable of preparing a medical device for use. It remains the responsibility of the processor</p>	

to ensure that the processing, as actually performed using equipment, materials and personnel in the processing facility, achieves the desired result. This requires verification and/or validation and routine monitoring of the process. Likewise, any deviation by the processor from the instructions provided should be properly evaluated for effectiveness and potential adverse consequences.

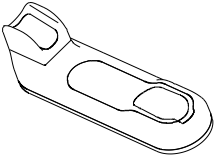
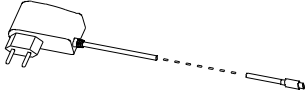
### 8.4 Disinfection Components

Disinfection components		
<p>Motor Handpiece</p> 	<p>Handpiece Base</p> 	<p>Adapter</p> 
<p>Wipe all the surfaces with a cloth lightly moistened with Ethanol for Disinfection (Ethanol 70 to 80vol%) at least 2min, repeat for 5 times.</p>		
<p> <b>NOTE</b></p> <ol style="list-style-type: none"> <li>1. Do not use disinfectants other than alcohol for disinfection.</li> <li>2. Do not use excessive alcohol to prevent alcohol from seeping into the parts and damaging the internal parts.</li> <li>3. Disinfect before and after each use.</li> </ol>		

## 9. Error warnings

<p><b>Overload</b> Restart Motor</p>	<p>This warning will appear on the display screen if the load exceeds the capacity of the standby machine during reversal. Please press the main switch key to restart the standby machine.</p>
<p><b>Low Power</b> Please Charge</p>	<p>The power is very low, charge it immediately.</p>

## 10.Troubleshooting

When trouble is found, check the following points before contacting your distributor. If none of these are applicable or the trouble is not remedied even after action has been taken, the product may have failed. Contact your distributor.

Problem	Cause	Solution
Cannot power on	Low battery	Charge the handpiece
	The duration of pressing the main switch is too short.	Press the main switch for more than 0.5 seconds
Charging indication does not appear on the handpiece screen	Wrong power adapter is used	Please use the original power adapter
	The power adapter is not plugged into the socket	Please check the connection
	The socket is not energized	Please check the connection
Handpiece screen does not display any information	The handpiece is damaged	Long press the main switch to start the device, check whether the sound is normal, and press the main switch again to check whether there is the sound of motor rotation. Then contact the dealer.
The motor does not rotate	Contra angle stuck	Pull out the contra angle and check whether the motor rotates. If it can rotate normally, please clean or repair the contra angle



## 10 Troubleshooting

	The handpiece is protected or damaged by the system	Check according to error warning
The motor cannot stop	There is a short circuit in the internal circuit	Press the "s" key to stop the motor and contact the dealer
The motor reverses uncontrollably	The reverse value of the torque setting is reached	Check whether the torque limit is too small
	Rev inversion mode is set	Check settings
Motor does not reverse	Excessive torque reversal value is set	Check settings
Frequent switching between forward and reverse rotation of motor	Rec (reciprocating) operation mode is set	If not, switch the operation mode
No sound	Volume set to "mute"	Set the volume to low, mid, or high
The handpiece sends out a continuous alarm.	Rev is set	If the setting is expected, ignore the alarm

## 11. Technical Data

Manufacturer	Changzhou Sifary Medical Technology Co., Ltd
Model	E-xtreme
Dimensions	17.5cm x 10.9cm x 8.4cm±1cm (Outer box)
Weight	0.6kg±15%
Contra angle	Compatible with rotary and reciprocating instruments, equipped with 2.35mm nickel titanium root canal file conforming to ISO 1797:2017, Type 1, Files length 11-31mm.
Power supply	Lithium ion battery: 3.7V, 800mAh, ±10%
Charger power supply	AC 100-240 V, ±10%
Charger power output	5V $\overline{\text{---}}$ 1A
Frequency	50/60Hz, ±1Hz
Charger nominal power input	0.4A Max
Torque range	0.5 – 4.0N·cm
Speed range	120-650 rpm
Type of protection against electrical shock	Class II and internally powered equipment
Applied part	B
Operation mode	Intermittent operation, working for 60 minutes / stopping for 5 minutes
Ingress Protection	IPX0
Operation conditions	Use: in enclosed spaces Ambient temperature: 5°C ~ 40 °C Relative humidity: <80% Operating altitude < 3000m above sea level

## 11 Technical Data

Transport and storage conditions	Ambient temperature: -20 °C ~ +55 °C Relative humidity: 20% ~ 80 % Atmospheric pressure: 70kPa ~ 106kPa
----------------------------------	---

## 12.EMC Tables

<b>Guidance and manufacturer' s declaration - electromagnetic emissions</b>		
The <b>E-xtreme</b> is intended for use in the electromagnetic environment specified below. The customer or the user of the <b>E-xtreme</b> should assure that it is used in such an environment.		
<b>Emissions test</b>	<b>Compliance</b>	<b>Electromagnetic environment - guidance</b>
RF emissions CISPR 11	Group 1	The <b>E-xtreme</b> uses RF energy only for its internal function. Therefore, its RF emissions are very low and are not likely to cause any interference in nearby electronic equipment.
RF emissions CISPR 11	Class B	The <b>E-xtreme</b> is suitable for use in all establishments, including domestic establishments and those directly connected to the public low voltage power supply network that supplies buildings used for domestic purposes.
Harmonic emissions IEC61000-3-2	Class A	
Voltage fluctuations/flicker emissions IEC 61000-3-3	Complies	

<b>Guidance and manufacturer' s declaration – electromagnetic immunity</b>			
The <b>E-xtreme</b> is intended for use in the electromagnetic environment specified below. The customer or the user of the <b>E-xtreme</b> should assure that it is used in such an environment.			
<b>Immunity test</b>	<b>IEC 60601 test level</b>	<b>Compliance level</b>	<b>Electromagnetic environment - guidance</b>

11 Technical Data

<p>Electrostatic discharge (ESD) IEC 61000-4-2</p>	<p>+/- 8 kV contact  +/- 2 kV, +/- 4 kV, +/- 8 kV, +/- 15 kV air</p>	<p>+/- 8 kV contact  +/- 2 kV, +/- 4 kV, +/- 8 kV, +/- 15 kV air</p>	<p>Floors should be wood, concrete or ceramic tile. If floors are covered with synthetic material, the relative humidity should be at least 30 %.</p>
<p>Electrical fast transients/bursts IEC 61000-4-4</p>	<p>±2kV 100kHz repetition frequency</p>	<p>±2kV 100kHz repetition frequency</p>	<p>Mains power quality should be that of a typical commercial or hospital environment.</p>
<p>Surge IEC 61000-4-5</p>	<p>Line to line: ±0.5kV, ±1kV  Line to earth: ±0.5kV, ±1kV, ±2kV</p>	<p>Line to line: ±0.5kV, ±1kV  Line to earth: ±0.5kV, ±1kV, ±2kV</p>	<p>Mains power quality should be that of a typical commercial or hospital environment.</p>

11 Technical Data

<p>Voltage dips IEC 61000-4-11</p>	<p>0% UT; 0.5 cycle at 0°, 45°, 90°, 135°, 180°, 225°, 270°, and 315°</p> <p>0% UT; 1 cycle and 70% UT; 25/30 cycles sine phase at 0°</p>	<p>0% UT; 0.5 cycle at 0°, 45°, 90°, 135°, 180°, 225°, 270°, and 315°</p> <p>0% UT; 1 cycle and 70% UT; 25/30 cycles sine phase at 0°</p>	<p>Mains power quality should be that of a typical commercial or hospital environment. If the user of devices require continued operation during power mains interruptions, it is recommend- ded that devic- es be powered form an uninterruptible power supply or a battery</p>
<p>Voltage interruptions IEC 61000-4-11</p>	<p>0% UT; 250/300 cycle</p>	<p>0% UT; 250/300 cycle</p>	<p>0% UT; 250/300 cycle</p>
<p>Rated Power frequency magnetic field IEC 61000-4-8</p>	<p>30 A/m 50Hz or 60Hz</p>	<p>30 A/m 50Hz or 60Hz</p>	<p>Power freque- ncy magnetic field should be at levels chara- cteristic of a typical location in a typical commercial or hospital environment.</p>
<p>Note: UT: rated voltage(s); E.g. 25/30 cycles means 25 cycles at 50Hz or 30 cycles at 60Hz</p>			

<b>Guidance and manufacturer' s declaration – electromagnetic immunity</b>			
The <b>E-xtreme</b> is intended for use in the electromagnetic environment specified below. The customer or the user of the <b>E-xtreme</b> should assure that it is used in such an environment.			
<b>Immunity test</b>	<b>IEC 60601 test level</b>	<b>Compliance level</b>	<b>Electromagnetic environment - guidance</b>
Conducted disturbances induced by RF fields IEC 61000-4-6	3 V 0.15 MHz – 80 MHz, 6 V in ISM bands between 0.15 MHz and 80 MHz, 80 % AM at 1 kHz	3 V	Portable and mobile RF communications equipment should be used no closer to any part of the <b>E-xtreme</b> , including cables, than the recommended separation distance calculated from the equation applicable to the frequency of the transmitter.  <b>Recommended minimum separation distances</b> See the RF wireless communication equipment table in "Recommended minimum separation distances"
Radiated RF EM fields IEC 61000-4-3	3 V/m, 80 MHz – 2,7 GHz, 80 % AM at 1 kHz	3V/m	
Proximity fields from RF wireless communication equipment IEC 61000-4-3	See the RF wireless communication equipment table in "Recommended minimum separation distances"	Complies	

<b>Recommended minimum separation distances</b>						
<p>Nowadays, many RF wireless equipments have being used in various healthcare locations where medical equipment and/or systems are used. When they are used in close proximity to medical equipment and/or systems, the medical equipment and/or systems' basic safety and essential performance may be affected. The <b>E-xtreme</b> has been tested with the immunity test level in the below table and meet the related requirements of IEC 60601-1-2:2014. The customer and/or user should help keep a minimum distance between RF wireless communications equipments and the <b>E-xtreme</b> as recommended below.</p>						
<b>Test frequency (MHz)</b>	<b>Band (MHz)</b>	<b>Service</b>	<b>Modulation</b>	<b>Maximum power (W)</b>	<b>Distance (m)</b>	<b>Immunity test level (V/m)</b>
385	380-390	TETRA 400	Pulse modulation 18Hz	1.8	0.3	27
450	430-470	GMRS 460 FRS 460	FM $\pm$ 5 kHz deviation 1 kHz sine	2	0.3	28
710	704-787	LTE Band 13, 17	Pulse modulation 217Hz	0.2	0.3	9
745						
780						
810	800-960	GSM 800/900 , TETRA 800, iDEN 820,	Pulse modulation 18Hz	2	0.3	28
870						



930		CDMA 850, LTE Band 5				
1720	1700 -199 0	GSM 1800; CDMA 1900; GSM 1900; DECT; LTE Band 1, 3, 4, 25; UMTS	Pulse modu- lation 217Hz	2	0.3	28
1845						
1970						
2450	2400 -257 0	Bluetoo- th, WLAN, 802.11 b/g/n, RFID 2450, LTE Band 7	Pulse modu- lation 217Hz	2	0.3	28
5240	5100 -580 0	WLAN 802.11 a/n	Pulse modu- lation 217Hz	0.2	0.3	9
5500						
5785						

**WARNING**

1. Use of accessories and cables other than those specified or provided by the manufacturer of **E-xtreme** could result in increased electromagnetic emissions or decreased electromagnetic immunity of **E-xtreme** and result in improper operation.

**Cable information:**

Cable Name	Cable Length (m)	Shielded or not	Remark
Adapter Cable	1.2	No	/

2. Use of **E-xtreme** adjacent to or stacked with other equipment should be avoided because it could result in improper operation. If such use is necessary, **E-xtreme** and the other equipment should be observed to verify that they are operating normally.