

ScanX Edge

EN-
US

Installation and Operating Instructions



RxOnly

AIR equipped for life®
TECHNIQUES

2160100287L41



G8302

1911V006



Contents



Important information

1	About this document	3
1.1	Warnings and symbols	3
1.2	Copyright information	4
2	Safety	5
2.1	Unauthorised modification	5
2.2	CE-Certification	5
2.3	FDA-Registration	5
2.4	General safety information	6
2.5	Specialist personnel	6
2.6	Protection from electric shock	6
2.7	FCC note	6
2.8	Essential performance characteristics	7
2.9	Notification requirement of serious incidents	7
2.10	Only use genuine parts	7
2.11	Transport	7
2.12	Disposal	7
2.13	Protection from cybersecurity threats	8



Product description

3	Overview	9
3.1	Scope of delivery	10
3.2	Accessories	10
3.3	Optional items	10
3.4	Consumables	10
3.5	Wear parts and spare parts	10
4	Technical data	11
4.1	Imaging plate scanner	11
4.2	Phosphor storage plate	14
4.3	Barrier envelope	15
4.4	Model identification plate	16
4.5	Conformity assessment	16
5	Function	16
5.1	Imaging plate scanner	16
5.2	Cartridges (S0-S2)	17

5.3	Phosphor storage plate	18
5.4	Barrier envelope	18



Installation

6	Requirements	19
6.1	Installation/setup room	19
6.2	System requirements	20
6.3	Monitor	21
7	Installation	21
7.1	Setting up the unit	21
7.2	Electrical connection	22
7.3	Connecting the unit to the network	23
8	Commissioning and first start-up	24
8.1	Configuring the network	24
8.2	Configuring the unit in VisionX	25
8.3	Configuring the unit in DBSWIN	25
8.4	X-ray unit settings	27
8.5	Commissioning tests	28



Usage

9	Correct use of phosphor storage plates	29
10	Operation	30
10.1	Changing the input unit cartridge	30
10.2	X-ray	31
10.3	Scanning the image data	33
10.4	Erasing the imaging plate	35
10.5	Switching the unit off	35
11	Cleaning and disinfection	36
11.1	Imaging plate scanner	36
11.2	Barrier envelope	36
11.3	Phosphor storage plate	36
12	Maintenance	37
12.1	Recommended maintenance schedule	37
12.2	Check image quality	37



Troubleshooting

13 Tips for operators and service technicians	39
13.1 Poor X-ray image	39
13.2 Software error	42
13.3 Fault on the unit	43



Appendix

14 Scanning times	45
15 File sizes (uncompressed)	46
16 Handover record	47

! Important information

1 About this document

These installation and operating instructions are an integral part of the unit.

 Air Techniques shall not be held liable and offers no guarantees of the safe and smooth operation of this unit if you fail to comply with notes and instructions contained in these Installation and Operating Instructions.

The German version of the installation and operating instructions is the original manual. All other languages are translations of the original manual. These operating instructions are valid for the following ScanX Edge versions:

Item number:

- G8300 (2160100510)
- G8300J (2160100511)
- G8300K (2160100512)
- G8300C (2160100513)

1.1 Warnings and symbols

Warnings

The warning notes in this document highlight possible injury to persons or damage to machinery. They are marked with the following warning symbols:

 General warning symbol

The warnings are structured as follows:

 **SIGNAL WORD**

Description of type and source of danger

Here you will find the possible consequences of ignoring the warning

➤ Follow these measures to avoid the danger.

The signal word differentiates between different levels of danger:

- **DANGER**
Direct danger of severe injury or death
- **WARNING**
Possible danger of severe injury or death
- **CAUTION**
Risk of minor injuries
- **NOTICE**
Risk of extensive material/property damage

Adhesive label

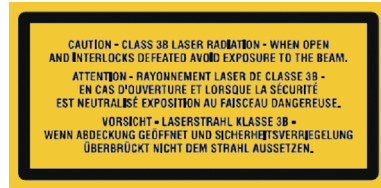

Fig. 1: Laser class 3B

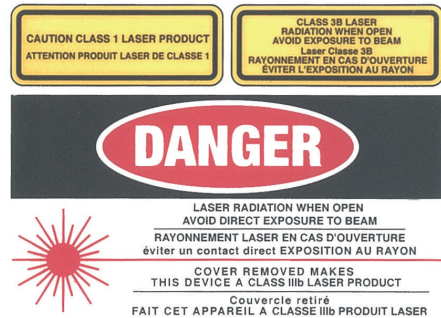

Fig. 2: Warning - laser beams

Closed device: Laser class 1
Open device: Laser class 3B

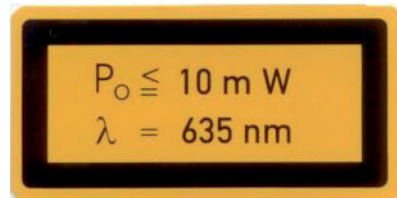



Fig. 3: Specification of laser source

! Important information

EN-
US

Miscellaneous symbols

These symbols are used in the document and on or in the unit:

 Note, e.g. specific instructions regarding the efficient use of the unit.

 Part number

 Serial number

 Medical device

 Health Industry Bar Code (HIBC)

 CE mark

 Manufacturer

 Dispose of correctly in accordance with EU Directive 2012/19/EU (WEEE).

 Take note of the accompanying electronic documents.

 Refer to Operating Instructions.

 Wear hand protection.

 Disconnect all power from the unit.

 Do not reuse

 DC current

 Non-ionizing electro-magnetic radiation

 Warning – risk of dangerous electric voltages

 Warning - laser beams

 Damage to components due to electrostatic discharges (ESD)

 This way up / store and transport in an upright position

 Keep dry

 Stacking limits

 Lower and upper humidity limits

 Lower and upper temperature limits

 Lower and upper atmospheric pressure limits

 Fragile, handle with care

 Keep away from sunlight during storage

1.2 Copyright information

All electronic drawings, processes, names, software, and appliances mentioned here are protected under copyright.

Printing or copying these Installation and Operating Instructions, including excerpts thereof, may only be carried out with the written approval of Air Techniques.

2 Safety

The unit has been developed and designed appropriately such that hazards are largely excluded if the unit is used in accordance with its Normal Use.

Therefore, please note the following.

Despite this, the following residual risks can remain:

- Personal injury due to incorrect use/misuse
- Personal injury due to mechanical effects
- Personal injury due to electric shock
- Personal injury due to radiation
- Personal injury due to fire
- Personal injury due to thermal effects on the skin
- Personal injury due to lack of hygiene, e.g. infection

2.1 Unauthorised modification

Pursuant to Part 15.21 of the FCC rules, any changes or modifications to this equipment not expressly approved by Dürr Dental may cause, harmful interference and void the FCC authorization to operate this equipment.

2.2 CE-Certification

ScanX Edge

Intended purpose (CE)

The ScanX Edge is intended to be used for scanning and processing digital images exposed on Phosphor Storage Plates (PSPs) in dental applications.

Intended use (CE)

The unit may only be operated with accessories and optional articles specified or approved by Air Techniques.

The unit may be cleaned only with the disinfectants and cleaning agents specified or approved by Air Techniques.

Improper use

Any other usage or usage beyond this scope is deemed to be improper. The manufacturer accepts no liability for damages resulting from improper usage. The user bears the sole risk. This unit is not suitable for monitoring patients over longer periods of time. This unit must not be operated in operating theatres or similar rooms, in which dangers may arise from the combustion of flammable materials.

Barrier envelope

Intended purpose (CE)

Disposable Barrier Envelope are intended to be used as a disposable barrier for the Air Techniques Phosphor Storage Plates. The device is non-sterile and intended for single patient use only.

Indication for use

Disposable Barrier Envelope are intended to be used as a disposable barrier for the Air Techniques Phosphor Storage Plates. The device is non-sterile and intended for single patient use only.

2.3 FDA-Registration

ScanX Edge

Intended use

The ScanX Edge is intended to be used for scanning and processing digital images exposed on Phosphor Storage Plates (PSPs) in dental applications.

Contraindication

Any other usage or usage beyond this scope is deemed to be improper. The manufacturer accepts no liability for damage resulting from improper usage. The user bears the sole risk. This unit is not suitable for monitoring patients over longer periods of time. This unit must not be used in operating rooms, in which hazards may arise from the combustion of flammable materials.

Barrier envelope

Intended use (FDA)

Disposable Barrier Envelope are intended to be used as a disposable barrier for the Air Techniques Phosphor Storage Plates. The device is non-sterile and intended for single patient use only.

Indication for use

Disposable Barrier Envelope are intended to be used as a disposable barrier for the Air Techniques Phosphor Storage Plates. The device is non-sterile and intended for single patient use only.

Contraindication

This Device has no contraindications.

2.4 General safety information

The sale or prescription of this device by a medical practitioner is subject to the restrictions of the applicable Federal Acts. The device may be used only under permanent supervision by a dentist or licensed medical practitioner.

Rx_{only} Caution: Federal law restricts this device to sale by or on the order of a Doctor.

- › Comply with the guidelines, laws, rules and regulations applicable at the site of operation when you use this unit.
- › Prior to each use, check the function and proper condition of the device.
- › Do not convert or modify the unit.
- › Comply with the Installation and Operating Instructions.
- › Make the Installation and Operating Instructions always available to the operator in the vicinity of the device.

2.5 Specialist personnel

Operation

Persons operating the unit must ensure safe and correct handling based on their training and knowledge.

- › Instruct or have every user instructed in handling the unit.

Installation and repairs

- › All installation, resetting, alteration, expansion, and repair work must be carried out either by Air Techniques personnel or by a suitably qualified person approved by Air Techniques.

2.6 Protection from electric shock

- › Working on the unit, comply with all the relevant electrical safety regulations.
- › Never touch the patient and unshielded plug connections or metallic parts of the device at the same time.
- › Immediately replace any damaged cables or plugs.

Comply with the EMC rules concerning medical devices

- › The unit is intended for use in professional healthcare facilities (in accordance with IEC 60601-1-2). If the unit is operated in any other environment, potential effects on the electromagnetic compatibility must be taken into account.
- › Do not use the device near HF surgical devices and MRI equipment.
- › Keep a minimum distance of 30 cm between the device and other electrical devices.
- › Keep a minimum distance of 30 cm between the unit and portable and mobile radio devices.
- › Note that cable lengths and cable extensions have effects on electromagnetic compatibility.
- › No maintenance measures are required to maintain the basic EMC safety.



NOTICE

Negative effects on the EMC due to non-authorized accessories

- › Use only Air Techniques accessories or accessories approved by Air Techniques.
- › Using any other accessories may result in increased electromagnetic interference emissions or the unit having reduced electromagnetic immunity, leading to an erroneous operation mode.



NOTICE

Erroneous operation mode due to use immediately adjacent to other devices or with other stacked devices

- › Do not stack the unit together with other devices.
- › If this is unavoidable, the unit and other devices should be monitored in order to ensure that they are working correctly.

2.7 FCC note

This equipment has been tested and found to comply with the limits for a Class B digital device, pursuant to part 15 of the FCC Rules. These limits are designed to provide reasonable protection against harmful interference in a residential installation. This equipment generates, uses and can

radiate radio frequency energy and, if not installed and used in accordance with the instructions, may cause harmful interference to radio communications. However, there is no guarantee that interference will not occur in a particular installation. If this equipment does cause harmful interference to radio or television reception, which can be determined by turning the equipment off and on, the user is encouraged to try to correct the interference by one or more of the following measures:

- › Reorient or relocate the receiving antenna.
- › Increase the separation between the equipment and receiver.
- › Connect the equipment into an outlet on a circuit different from that to which the receiver is connected.
- › Consult the dealer or an experienced radio/TV technician for help.

2.8 Essential performance characteristics

The ScanX Edge does not have any essential performance characteristics as set out in IEC 60601-1 (EN 60601-1) section 4.3. The unit meets the requirements according to IEC 60601-1-2:2014.

2.9 Notification requirement of serious incidents

The operator/patient has to report any serious incident related the product to the manufacturer and the competent authority of the Member State, in which the operator and/or patient is established/resident.

2.10 Only use genuine parts

- › Only Air Techniques accessories and special accessories or those approved by Air Techniques may be used.
- › Only use original spare and replacement parts.



Air Techniques accepts no liability for damage resulting from the use of non-approved accessories, special accessories or any parts other than original spare and wear parts.

The use of non-approved accessories, special accessories or non-genuine working parts / spare parts (e.g. mains cable) can have a negative effect on the electrical safety and EMC.

2.11 Transport

Only the original packaging ensures optimum protection for the unit during transport. If necessary, the original packaging for this unit can be ordered from Air Techniques.



Air Techniques cannot be held responsible for any damage resulting from transport in unsuitable packaging, even during the warranty period.

- › Only transport the unit in its original packaging.
- › Keep all packaging away from children.
- › Do not expose the unit to any strong vibrations or shocks.

2.12 Disposal

Europe



An overview of the waste keys for Dürr Dental products can be found in the download area at www.duerdental.com (document no. P007100155).

Device



Dispose of the unit correctly. Within the European Union, the unit must be disposed of in accordance with EU Directive 2012/19/EU (WEEE).

- › If you have any questions about the correct disposal of parts, please contact your dental trade supplier.

Phosphor storage plate

The image plate contains barium compounds.

- › Dispose of the image plate properly in accordance with locally applicable regulations.
- › In Europe, dispose of the image plate in accordance with waste code 090199 "Waste not otherwise specified". Disposal as domestic waste is not possible.

Rest of world

Disposal of the units, electronic circuitry and PSPs must be accomplished only at the appropriate facilities for recovery and recycling. Make sure to dispose of such items in accordance with current federal, national, state and local government rules and regulations.

2.13 Protection from cybersecurity threats

The unit is to be connected to a computer that can be connected to the Internet. Therefore, the system needs to be protected from threats from the Internet.

- › Use antivirus software and update it regularly. Look for evidence of possible virus infection and, if applicable, check with the antivirus software and remove the virus.
- › Perform regular data backups.
- › Provide access to units only to trustworthy users, e.g. by means of user name and password.
- › Make sure that only trustworthy contents are downloaded. Install manufacturer-authenticated software and firmware updates only.

 Product description

3 Overview

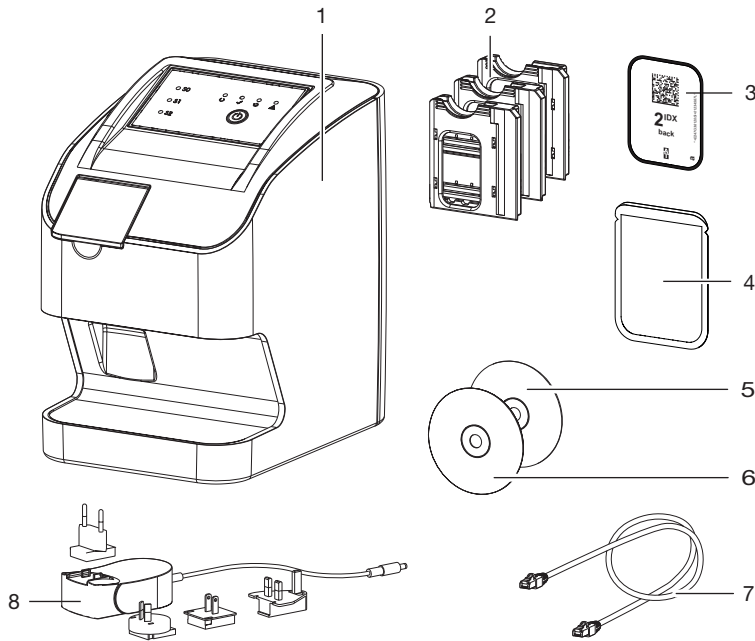

- 1 ScanX Edge phosphor storage plate scanner
- 2 Cartridge for phosphor storage plates (S0 to S2)
- 3 Phosphor storage plate IDX
- 4 Barrier envelope
- 5 VisionX imaging software DVD
- 6 DBSWIN imaging software DVD
- 7 Network cable (3 m)
- 8 Power supply unit with country-specific adapter

3.1 Scope of delivery

The following items are included in the scope of delivery (possible variations due to country-specific requirements and/or import regulations):

- ScanX Edge phosphor storage plate scanner system** G8300A
- ScanX Edge phosphor storage plate scanner system** G8300AJ
- ScanX Edge phosphor storage plate scanner system** G8300AK
- ScanX Edge phosphor storage plate scanner system** G8300AC
- ScanX Edge basic unit
 - Power supply
 - Network cable (3 m)
 - Collector mat (mounted in the device)
 - VisionX imaging software DVD
 - DBSWIN imaging software DVD
 - Cartridge for phosphor storage plate size 2
 - Phosphor storage plates IDX:
 - Size 2
 - Barrier envelopes:
 - Size 2
 - Installation and Operating Instructions
 - Quick Start Guide

3.2 Accessories

The following items are required for operation of the device, depending on the application:

- Phosphor storage plates (PSPs)**
- Phosphor storage plate IDX Size 0
 - Phosphor storage plate IDX Size 1
 - Phosphor storage plate IDX Size 2

Barrier envelopes

- Barrier envelope Size 0
- Barrier envelope Size 1
- Barrier envelope Size 2

3.3 Optional items

The following optional items can be used with the device:

- Wall mount G8321

Commissioning and intraoral constancy tests

- 2D X-ray test phantom G8795

3.4 Consumables

The following materials are consumed during operation of the device and must be re-ordered:

Cleaning and disinfection

- PSP cleaning wipes (50 pieces) B8910

Barrier envelopes

- Barrier envelope Size 0
2 x 3 cm (100 pcs.) G8511-0
- Barrier envelope Size 1
2 x 4 cm (100 pcs.) G8511-1
- Barrier envelope Size 2
3 x 4 cm (300 pcs.) G8511-2
- Barrier envelope Size 2
3 x 4 cm (1000 pcs.) G8511-2k

3.5 Wear parts and spare parts

Phosphor storage plates (PSPs)

- Phosphor storage plate IDX Size 0 (2 pieces) G3620
- Phosphor storage plate IDX Size 1 (2 pieces) G3621
- Phosphor storage plate IDX Size 2 (4 pieces) G3622
- Phosphor storage plate IDX Size 2 (12 pieces) G3631

Cartridges

- Cartridge for phosphor storage plate
S0 G8310-0
- Cartridge for phosphor storage plate
S1 G8310-1
- Cartridge for phosphor storage plate
S2 G8310-2

4 Technical data

4.1 Imaging plate scanner

Electrical data for the device

Nominal voltage	V DC	24
Max. current consumption	A	0.5
Max. power consumption	W	< 12

Electrical data of the power supply unit

Nominal input voltage	V AC	100 - 240
Frequency	Hz	50/60
Nominal output voltage	V DC	24
Max. output current	A	0.5

General technical data

Dimensions (W x H x D)	mm	167 x 231 x 216
	in	6.57 x 9.09 x 8.50
Weight	kg	approx. 4
	lb	approx. 8.82
Duty Cycle	%	100
Max. theoretical resolution	Line pairs/mm (Lp/mm)	approx. 16.7

Noise level

During scanning	dB(A)	approx. 45
-----------------	-------	------------

Network connection

LAN technology		Ethernet
Standard		IEEE 802.3u
Data rate	Mbit/s	100
Connector		RJ45
Type of connection		Auto MDI-X
Type of cable		≥ CAT5

Ambient conditions during operation

Temperature	°C	+10 to +35
	°F	+50 to +95
Relative humidity	%	20 - 80
Air pressure	hPa	750 - 1060
Elevation above sea level	m	< 2000
	ft	< 6562

 Product description

Ambient conditions during storage and transport

Temperature	°C	-18 to +60
	°F	-4 to +140
Humidity	%	10 - 95, non-condensing
Air pressure	hPa	500 - 1060

Classification

Medical device of class	Class I
FDA classification (CFR Title 21)	Class II
Laser class (unit)	1
In accordance with IEC 60825-1	

Laser source

Laser class	3B	
In accordance with IEC 60825-1:2014		
Wavelength λ	nm	635
Output	mW	<10

Technical data of the RFID module

Frequency	MHz	13.56
Modulation		ASK
Max. power	mW	400

Electromagnetic compatibility (EMC)
Interference emission measurements

High-frequency emissions in accordance with CISPR 11	Group 1 Class B
Interference voltage at the power supply connection CISPR 11:2009+A1:2010	Conforms
Electromagnetic interference radiation CISPR 11:2009+A1:2010	Conforms

Electromagnetic compatibility (EMC)
Interference immunity measurements on cover

Immunity to interference by discharge of static electricity IEC 61000-4-2:2008 ± 8 kV contact ± 2 kV, ± 4 kV, ± 8 kV, ± 15 kV air	Conforms
Immunity to interference by high-frequency electromagnetic fields IEC 61000-4-3:2006+A1:2007+A2:2010 3 V/m 80 MHz - 2.7 GHz 80 % AM at 1 kHz	Conforms

Electromagnetic compatibility (EMC) Interference immunity measurements on cover

Immunity to interference by near fields of wireless HF communication devices

IEC 61000-4-3:2006+A1:2007+A2:2010

Conforms

See Table on immunity levels with respect to near fields of wireless HF communication devices

Immunity levels with respect to near fields of wireless HF communication devices

Radio service	Frequency band MHz	Test level V/m
TETRA 400	380 - 390	27
GMRS 460 FRS 460	430 - 470	28
LTE band 13, 17	704 - 787	9
GSM 800/900 TETRA 800 iDEN 820 CDMA 850 LTE band 5	800 - 960	28
GSM 1800 CDMA 1900 GSM 1900 DECT LTE bands 1, 3, 4, 25 UMTS	1700 - 1990	28
Bluetooth WLAN 802.11 b/g/n RFID 2450 LTE band 7	2400 - 2570	28
WLAN 802.11 a/n	5100 - 5800	9

Electromagnetic compatibility (EMC) Interference immunity measurements on supply input

Immunity to interference by rapid transient bursts – AC voltage grid

IEC 61000-4-4:2012

Conforms

± 2 kV

100 kHz repetition frequency

Immunity to interference, surges

IEC 61000-4-5:2005

Conforms

± 0.5 kV, ± 1 kV

Electromagnetic compatibility (EMC)

Interference immunity measurements on supply input

Immunity to interference, line-conducted disturbances induced by high-frequency fields – AC voltage grid

IEC 61000-4-6:2013

3 V

0.15 - 80 MHz

Conforms

6 V

ISM frequency bands

0.15 - 80 MHz

80 % AM at 1 kHz

Immunity to interference due to voltage dips, short interruptions and voltage fluctuations

Conforms

IEC 61000-4-11:2004

Electromagnetic compatibility (EMC)

Interference immunity measurements SIP/SOP

Immunity to interference by discharge of static electricity

IEC 61000-4-2:2008

± 8 kV contact

Conforms

± 2 kV, ± 4 kV, ± 8 kV, ± 15 kV air

Immunity to electrical fast transients/bursts – I/O,

SIP/SOP ports

IEC 61000-4-4:2012

Conforms

± 1 kV

100 kHz repetition frequency

Immunity to conducted disturbances, induced by radio-frequency fields – SIP/SOP ports

IEC 61000-4-6:2013

3 V

0.15 - 80 MHz

Conforms

6 V

ISM frequency bands

0.15 - 80 MHz

80 % AM at 1 kHz

4.2 Phosphor storage plate

Classification

Medical Devices of class

Class IIa

FDA classification (CFR Title 21)

Class I

Ambient conditions during operation

Temperature

°C

18 - 45

°F

64 - 113

Relative humidity

%

< 80

Ambient conditions during storage and transport

Temperature	°C	< 33
	°F	< 91
Relative humidity	%	< 80

Dimensions of intraoral phosphor storage plates

Size 0	mm	22 x 35
	inch	0.86 x 1.38
Size 1	mm	24 x 40
	inch	0.94 x 1.57
Size 2	mm	31 x 41
	inch	1.22 x 1.61

4.3 Barrier envelope**Classification**

Medical Devices Directive	Class I
FDA classification (CFR Title 21)	Class II

4.4 Model identification plate

The model identification plate is located on the rear of the device.

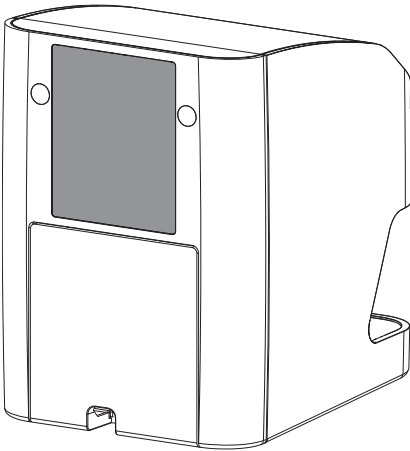

REF Order number
SN Serial number

4.5 Conformity assessment

This device has been subjected to conformity acceptance testing in accordance with the current relevant guidelines of the European Union. This equipment conforms to all relevant requirements.

Dürr Dental herewith declares that the radio equipment "ScanX Edge" meets the requirements of Directive 2014/53/EC.

5 Function

5.1 Imaging plate scanner

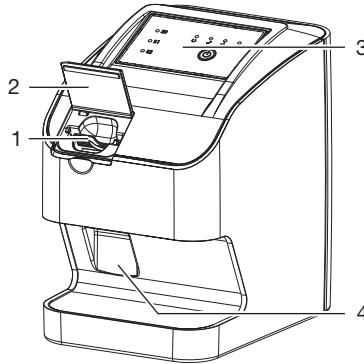

- 1 Input unit
- 2 Cover (open)
- 3 User interface
- 4 Collection tray

The phosphor storage plate scanner is used to read image data stored on a phosphorus storage plate and to transfer the data to an imaging software (e. g. VisionX) on a computer.





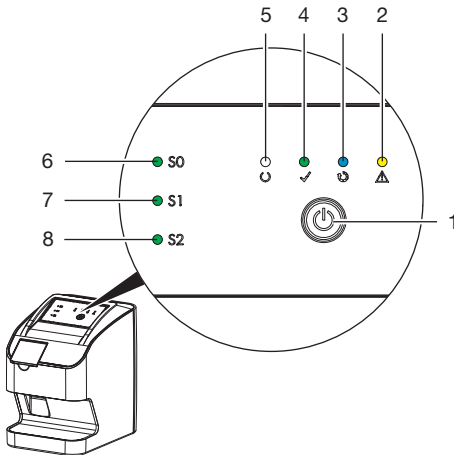















The transport mechanism guides the PSP through the unit. A laser in the scanner unit scans the PSP. The scanned data is converted into a digital image and transferred to the imaging software.

After scanning, the PSP runs through the erasure unit. Image data still present on the PSP is erased with the aid of bright light. The PSP is then ejected for re-use.

Operating elements

- 1 On/off switch
- 2 Error display yellow
- 3 Read display blue
- 4 Green status LED
- 5 Communication/standby display white
- 6 Display for cartridge S0
- 7 Display for cartridge S1
- 8 Display for cartridge S2

The status LEDs display the following status messages:

		Device starts
		Communication display Standby
		Ready to scan
		
		PSP currently being processed
		
		Cartridge for PSP missing
		
		Error
		A message is displayed in the software
S0		Cartridge for PSP S0 is inside the device

S1  Cartridge for PSP S1 is inside the device

S2  Cartridge for PSP S2 is inside the device

 Status LED flashes

Connections

The connections are located on the rear of the unit, underneath the cover.

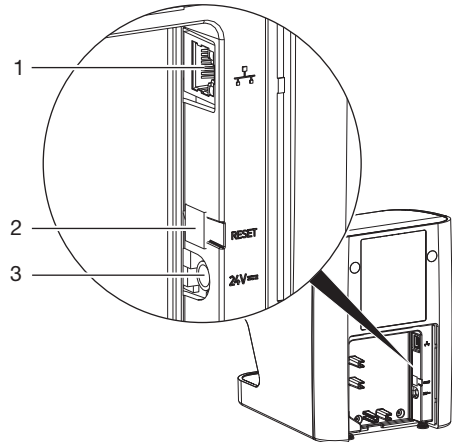

- 1 Network connection
- 2 Reset button
- 3 Connection for power supply unit

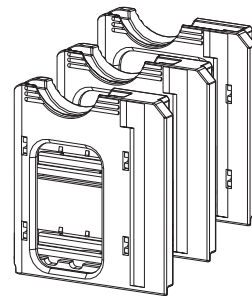
5.2 Cartridges (S0-S2)

Depending on the PSP used, the proper cartridge for the size of the PSP must be inserted in the device. The cartridge that is currently inside the device is indicated via the LEDs on the device.

5.3 Phosphor storage plate

The PSP stores X-ray energy, which is re-emitted in the form of light after excitation by the laser. This light is then converted into image information in the phosphor storage plate scanner. The PSP has an active side and an inactive side. The PSP must always be exposed on the active side.

When used properly, a PSP can be exposed, read and erased several hundred times provided there is no mechanical damage. The PSP must be replaced if there are any signs of damage, e.g. if the protective layer is damaged or there are visible scratches that could interfere with the diagnostics.

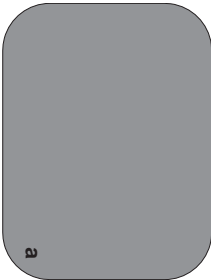
Inactive side	Active side
	
White, with "back", size and manufacturer's information printed on it	Light blue, with positioning aid a

Positioning aid **a** is visible on the x-ray image and makes orientation easier during diagnosis.

 Only use phosphor storage plate IDX with the unit. The unit is unable to read any other types of PSP.

5.4 Barrier envelope

Disposable Barrier Envelope are intended to be used as a disposable barrier for the Air Techniques Phosphor Storage Plates. The device is non-sterile and intended for single patient use only.



Only qualified specialists or persons trained by Air Techniques may install, connect, and commission the unit.

6 Requirements

6.1 Installation/setup room

The room chosen for set up must meet the following requirements:

- Closed, dry, well-ventilated room
- It should not be a room made for another purpose (e.g. boiler room or wet cell)
- Max. light intensity 1000 Lux, no direct sunlight at the place of installation of the unit
- There should be no major fields of interference (e.g. strong magnetic fields) present that can interfere with the proper operation of the unit.
- Ambient conditions correspond to "4 Technical data".

6.2 System requirements

The system requirements of the software being used to operate the device must always be met during its operation.

If third-party software is being used to operate the device, compliance with its system requirements must be assured.

The following additional system requirements must also be met:

Interface:	Ethernet \geq 100 Mbit
Diagnostic monitor:	In accordance with DIN 6868-157, room category 5 or 6 (depending on the requirements)
Software:	DBSWIN version 5.16 or higher (order number: E7200A), VistaEasy, Image Bridge VisionX version 2.4 or higher (order number: E7300)



For the system requirements of the computer systems, visit the download area at www.airtechniques.com (document no. E7201).

6.3 Monitor

The monitor must meet the requirements for digital X-ray with a high light intensity and wide contrast range.

Strong ambient light, sunlight impinging directly onto the monitor and reflections can make it more difficult or even impossible to perform a diagnosis based on the X-ray images.

7 Installation

7.1 Setting up the unit



NOTICE

Damage to sensitive components of the unit due to shocks or vibrations

- › Do not expose the unit to any strong vibrations or shocks.
- › Do not move the unit during operation.

Portable and mobile HF communication appliances can interfere with the effectiveness of electrical medical devices.

- › Do not stack the unit next to or together with other appliances.
- › If, however, this unit is operated next to other units or stacked with other units, monitor the unit carefully in the configuration selected in order to ensure normal operation.

The unit can be set up as a tabletop unit or mounted on a wall using the wall bracket.

The load-bearing capacity of the table or wall must be suitable for the weight of the unit (see "4 Technical data").

Setting the unit on a table



To prevent errors when scanning the image data, install the unit so it is not exposed to vibrations.

- › Place the unit on a firm, horizontal surface.

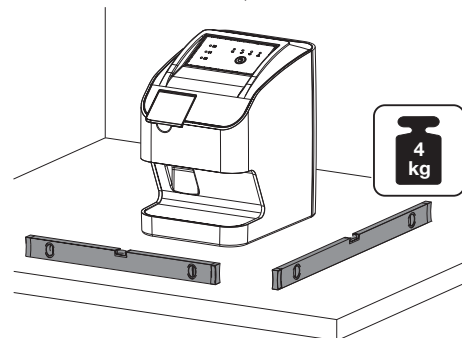

Installing the unit with the wall mounting bracket

The unit can be mounted on a wall with the wall mounting bracket (see "3.3 Optional items").

7.2 Electrical connection

Electrical safety when making connections

- › Connect the device to a correctly installed power outlet only.
- › Do not place non-fixed multi-socket units on the floor. Comply with the requirements in section 16 of IEC 60601-1 (EN 60601-1).
- › Do not operate any other systems using the same multiple socket.
- › Make sure that none of the electrical cables leading to the unit are under any mechanical tension.
- › Before initial start-up verify that the mains supply voltage and the voltage stated on the type plate match (see also "4. Technical data").

Connecting the unit to the mains supply



The unit has no main power switch. For this reason, it is important to set up the unit properly such that the plug can be easily accessed and unplugged if required.

Requirements:

- ✓ Properly installed power outlet close to the unit (observe the max. length of the power cord)
- ✓ Easily accessible power outlet
- ✓ Mains voltage matches the information shown on the type plate of the power supply unit



Only the supplied power supply unit may be used.

- › Attach the matching country-specific adapter to the power supply unit.

- › Remove the screw covers and screws from the bottom of the device.

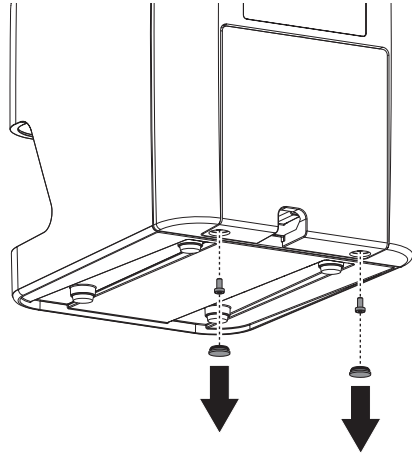

- › Remove the cover from the rear of the device.

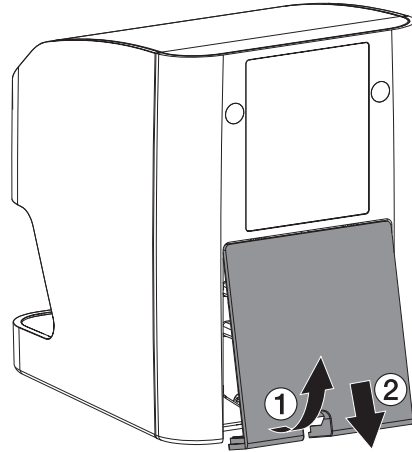

- › Plug the connecting plug of the power supply unit into the connection socket of the unit.

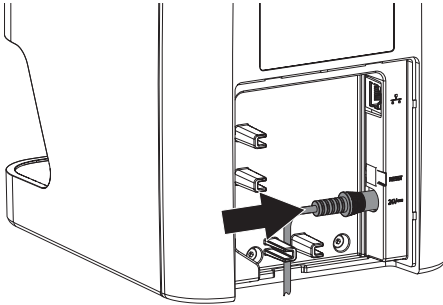

- › Plug the mains plug into the power outlet.
- › Replace the cover.



The cover on the rear must be properly installed when the device is operated within the patient environment.

7.3 Connecting the unit to the network

Purpose of the network connection

The network connection is used to exchange information or control signals between the unit and a software installed on a computer, in order to, e. g.:

- Display parameters
- Select operating modes
- Indicate messages and error situations
- Change device settings
- Activate test functions
- Transmit data for archiving
- Provide documents concerning the devices

The unit can be connected to the network with a network cable.

Combining devices safely

- Safety and essential performance features are independent of the network.
- Faulty manual configuration can lead to significant network problems. The expert knowledge of a network administrator is required for configuration.
- If, e. g., the following changes are made to the network, new risks can arise that require further analysis:
 - Changes in the IT network configuration
 - Connecting additional elements to the IT network
 - Removing elements from the IT network
 - "Update" of devices that are connected to the IT network
 - "Upgrade" of devices that are connected to the IT network
- The data connection utilizes part of the bandwidth of the network. Interactions with other medical devices cannot be completely excluded. Apply the IEC 80001-1 standard for risk assessment.
- The device is not suitable to be connected directly to the public internet.

Take care when connecting units together or to parts of other systems as there is always an element of risk (e.g. due to leakage currents).

- › Only connect units when there can be no question of danger to operator or to patient.
- › Only connect units when it is safe to do so and when there is no risk of damage or harm to the surroundings.
- › If it is not completely clear from the data sheet of the unit that such connections can be safely made or if you are in any doubt, always get a suitably qualified person (e.g. the relevant manufacturer) to verify that the setup is safe.
- › Comply with the specifications of IEC 60601-1 (EN 60601-1) when connecting the appliance with other appliances, e.g. a PC system, both in and outside the patient environment.
- › Only connect peripheral units (e.g. monitors, printers) that meet at least the requirements set out in IEC 60950-1 (EN 60950-1).
- › The connected computer must conform to EN 55032 (class B) and EN 55024.

Connecting the unit via the network cable

- › Remove the cover from the rear of the device.

- › Plug the enclosed network cable into the network socket of the device.

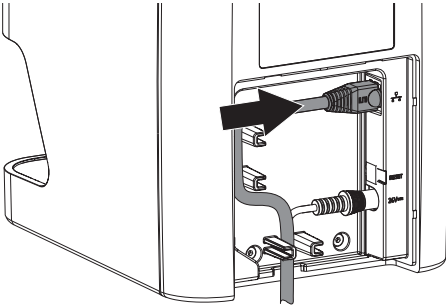

i The cover on the rear must be properly installed when the device is operated within the patient environment.

- › Replace the cover.

8 Commissioning and first start-up



NOTICE

Short circuit due to the build-up of condensation

- › Do not switch on the unit until it has warmed up to room temperature and is dry.

The unit supports the following imaging programs:

- VisionX manufactured for Air Techniques
- DBSWIN manufactured for Air Techniques
- Please inquire about third-party software



Always use the current version of the imaging program in the commissioning of the device. Check the version of the enclosed imaging program versus the versions available at www.airtechniques.com.

8.1 Configuring the network

Network configuration

Various options are available for network configuration:

- ✓ Automatic configuration via DHCP.
- ✓ Automatic configuration via Auto-IP for direct connection of device and computer.
- ✓ Manual configuration.
- › Configure the network settings of the device using the software or, if applicable, the touch screen.
- › Check the firewall and release the ports, if applicable.

Network protocols and ports

Port	Purpose	Service
45123 UDP, 45124 UDP	Device recognition and configuration	
2006 TCP	Device data	
514 ¹⁾ UDP	Event protocol data	Syslog

- 1) The port can vary depending on the configuration.



When the unit is first connected to a computer, it applies the language and time settings of the computer.

8.2 Configuring the unit in VisionX

Configuration is performed directly in VisionX.

- ›  **Select the units.**
- › Mark the connected unit in the list.

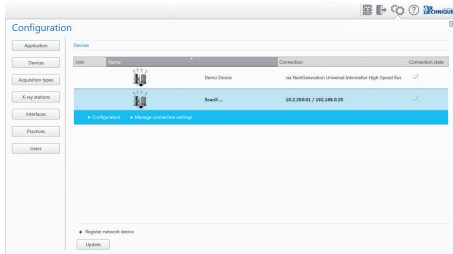

- › Click on **Edit connection settings**.
- › The unit name (designation) can be changed and information queried in **General**.
- › An IP address can be entered manually and DHCP can be activated / deactivated in **Connection**.
- › Extended functions e. g. IP address 2 can be set in **Extended**.

Entering a fixed IP address (recommended)



To reset the network settings, keep the unit reset key pressed for 15 - 20 seconds while switching on.

- › Deactivate DHCP in **Connection**.
- › Enter the IP address, subnet mask and gateway.
- › Navigate back to **Units** via the navigation bar or close Flyout using . This saves the configuration.

Testing the device

You can scan an X-ray image to check if the unit is properly connected.

- › Open VisionX.
- › Create an X-ray station for the connected unit.
- › Log-in the demo patient (patient ID: DEMO0001).
- › Select the acquisition type (e. g. Intraoral).
- › To scan a PSP, see "10.3 Scanning the image data".

8.3 Configuring the unit in DBSWIN

The configuration is done with VistaConfig, which is automatically installed during the installation of DBSWIN or VistaEasy.

- › **Start > All Programs > Air Techniques > VistaEasy > VistaConfig.**

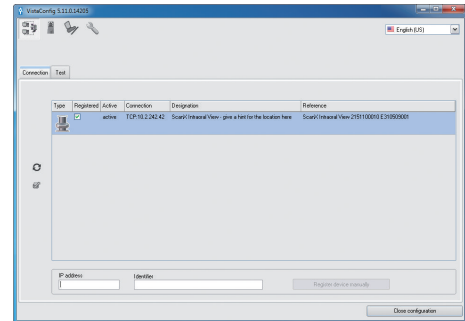

- › Click . This updates the list of connected devices.
- › If the device isn't found, enter the IP address manually and click **Register device manually**.
- › Activate the connected device in the **Registered** column. You can also register multiple devices.

Use the **ScanX device configuration** window to change the device name, (**name**), to manually enter an IP address and to request information.

- › Click .

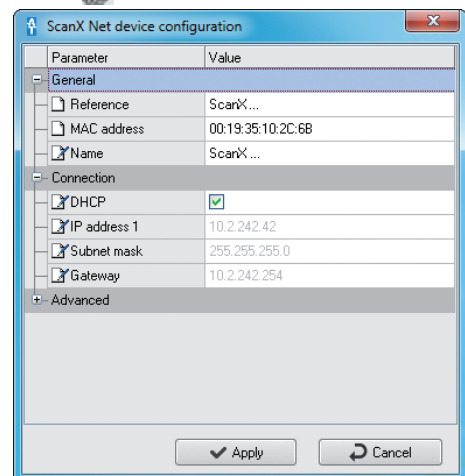

Entering a fixed IP address (recommended)

 To reset the network settings, keep the unit reset button pressed for 15 - 20 seconds while switching on.

- › Deactivate *DHCP*.
- › Enter the IP address, subnet mask and gateway.
- › Click on *Apply*.
This saves the configuration.

Testing the device

You can scan an X-ray image to check if the unit is properly connected.

- › Select the *Test* tab.

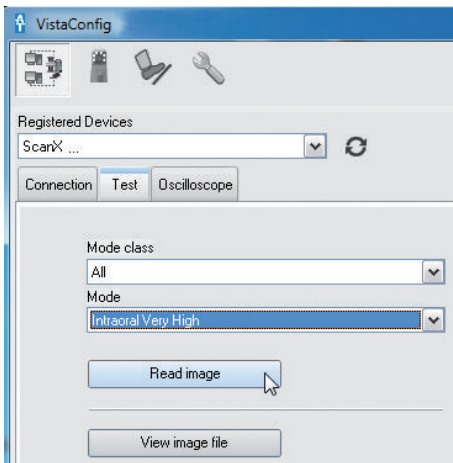

- › Select the unit from the *Registered Devices* selection list.
- › Select the mode class.
- › Select the mode.
- › Click on *Scan Image*.
- › For the scanning of an image plate, see "10.3 Scanning the image data".

8.4 X-ray unit settings



A setting of 60 kV is preferred provided it can be set on the X-ray unit.
The standard exposure values for F-speed film (e. g. Kodak Insight) can be used.

Intraoral X-ray units for an adult patient

The following table shows the standard values for the exposure time and the dose area product of a PSP for an adult patient.

	DC emitter, 7 mA Tube length 20 cm					
	without X-ray field limitation		X-ray field limitation 2x3		X-ray field limitation 3x4	
	60 kV	mGycm ²	60 kV	mGycm ²	60 kV	mGycm ²
Incisor	0.10 s	18.3	0.10 s	3.8	0.10 s	7.7
Premolar	0.14 s	25.6	0.14 s	5.4	0.14 s	10.8
Molar	0.19 s	34.8	0.19 s	7.3	0.19 s	14.7
Bitewings	0.21 s	38.4	0.21 s	8.1	0.20 s	15.5

	DC emitter, 6 mA Tube length 30 cm					
	without X-ray field limitation		X-ray field limitation 2x3		X-ray field limitation 3x4	
	60 kV	mGycm ²	60 kV	mGycm ²	60 kV	mGycm ²
Incisor	0.15 s	13.7	0.15 s	4.9	0.15 s	5.8
Premolar	0.20 s	18.2	0.20 s	3.8	0.20 s	7.7
Molar	0.27 s	24.6	0.27 s	5.2	0.27 s	10.4
Bitewings	0.28 s	25.5	0.29 s	5.6	0.28 s	10.8

› Check and adjust the specific X-ray unit in accordance with the standard values.

Intraoral X-ray units for a pediatric patient

The following table shows the standard values for the exposure time and the dose area product of a PSP for a pediatric patient.

	DC emitter, 7 mA Tube length 20 cm					
	without X-ray field limitation		X-ray field limitation 2x3		X-ray field limitation 3x4	
	60 kV	mGycm ²	60 kV	mGycm ²	60 kV	mGycm ²
Incisor	0.07 s	12.8	0.07 s	2.7	0.07 s	5.4
Premolar	0.09 s	16.4	0.09 s	3.4	0.09 s	6.9
Molar	0.13 s	23.8	0.13 s	5.0	0.13 s	10.1
Bitewings	0.15 s	27.4	0.13 s	5.0	0.13 s	10.1

	DC emitter, 6 mA Tube length 30 cm					
	without X-ray field limitation		X-ray field limitation 2x3		X-ray field limitation 3x4	
	60 kV	mGycm ²	60 kV	mGycm ²	60 kV	mGycm ²
Incisor	0.10 s	9.1	0.10 s	1.9	0.10 s	3.8
Premolar	0.13 s	11.8	0.13 s	2.5	0.13 s	5.0
Molar	0.16 s	14.8	0.16 s	3.1	0.16 s	6.2
Bitewings	0.16 s	14.8	0.16 s	3.1	0.16 s	6.2

› Check and adjust the specific X-ray unit in accordance with the standard values.

8.5 Commissioning tests

The required tests (e.g. acceptance test) must be done in accordance with local rules and regulations.

- › Find out which tests are required.
- › Carry out testing in accordance with local rules and regulations.

Acceptance check



The 2D X-ray test phantom is required for acceptance tests with the PSP and sensor as receivers, and possibly also the corresponding test phantom holder.

- › Before commissioning the unit, the acceptance test of the X-ray system must be carried out in accordance with national regulations.

The consistency tests, which must be carried out at regular intervals by the dental professional, are based on the results of the acceptance test.

Electrical safety checks

- › Carry out the electrical safety check according to national law (e. g. in accordance with IEC 62353).
- › Document the results.
- › Carry out and document the instruction and handover for the unit.



A sample handover report is included in the attachment.

 Usage

9 Correct use of phosphor storage plates

**WARNING**

Risk of cross contamination when not using the barrier envelope or when using the barrier envelope more than once

- › Do not use an phosphor storage plate without a barrier envelope.
- › Do not re-use the barrier envelope (disposable item).

**CAUTION**

Image data on the phosphor storage plate (PSP) is not permanent

The image data is altered by light, natural X-ray radiation and scattered X-ray radiation. This impairs the diagnostic information and clarity.

- › Read the image data within 30 minutes of exposure.
- › Never handle exposed PSPs without the barrier envelope.
- › Do not subject an exposed PSP to X-ray radiation before and during the scanning process.

Do not X-ray during the scanning process if the unit is in the same room as the X-ray tube.

**CAUTION**

Phosphor storage plates (PSP) are toxic

PSPs that are not used with a barrier envelope can lead to poisoning when placed in the mouth or swallowed.

- › Only place PSPs in the patient's mouth in a barrier envelope.
- › Do not swallow the PSP or parts of it.
- › If the PSP or parts of it have been swallowed, consult a specialist doctor immediately and remove the PSP.
- › If the barrier envelope was damaged in the patient's mouth, rinse the mouth thoroughly with copious amounts of water. Do not swallow the water in the process.

- › Phosphor storage plates must be read by a phosphor storage plate scanner from Air Techniques only.
- › Phosphor storage plates are flexible like X-ray film. However, the phosphor storage plates should not be kinked.

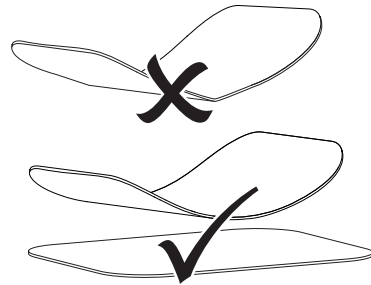

- › Do not scratch the phosphor storage plates. Do not subject the phosphor storage plates to pressure from hard or pointed objects.

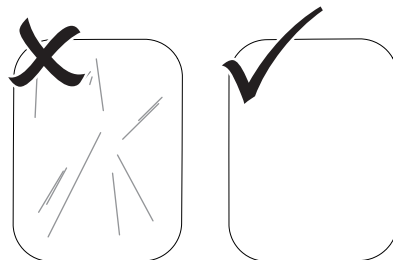

- › Do not soil the phosphor storage plates.

- › Protect the phosphor storage plates from sunlight and ultraviolet light.
Store phosphor storage plates in a barrier envelope of the correct size.
- › Phosphor storage plates will be pre-exposed on exposure to natural radiation and stray x-ray radiation. Protect erased or exposed phosphor storage plates from X-ray beams.
If the phosphor storage plate has been stored for longer than one week, erase the phosphor storage plate prior to use.
- › Do not store phosphor storage plates under hot or moist conditions. Note the ambient conditions (see "4 Technical data").
- › When used properly, phosphor storage plates can be exposed, read and erased several hundred times provided there is no mechanical damage.
Replace the phosphor storage plate if there are any signs of damage, e.g. if the protective layer is damaged or there are visible scratches that impair the quality of the diagnosis.
Also replace the phosphor storage plate if the RFID tag is damaged or becoming detached.
- › Phosphor storage plates that have a production or packaging defect will be replaced by Air Techniques in the same quantity. Claims can only be accepted within 7 working days after receipt of the goods.
- › Clean phosphor storage plates properly (see "11 Cleaning and disinfection").

10 Operation



CAUTION

Image data on the phosphor storage plate (PSP) is not permanent

The image data is altered by light, natural X-ray radiation and scattered X-ray radiation. This impairs the diagnostic information and clarity.

- › Read the image data within 30 minutes of exposure.
- › Never handle exposed PSPs without the barrier envelope.
- › Do not subject an exposed PSP to X-ray radiation before and during the scanning process.

Do not X-ray during the scanning process if the unit is in the same room as the X-ray tube.

10.1 Changing the input unit cartridge

The device can scan phosphor storage plates of size 0, size 1 and size 2. Each size of PSP requires the matching cartridge.
The size of the PSP is marked on the cartridge.



CAUTION

Loss of image information and equipment damage if the wrong cartridge is used

- › Always use the correct size of cartridge for the PSP being used.
- › Before each scanning process, compare the phosphor storage plate size with the LED display on the user interface.

- › Use the the display (S0, S1, S2) to check if the correct cartridge has been inserted.
If the wrong cartridge is inserted, it must be removed and the correct cartridge inserted.

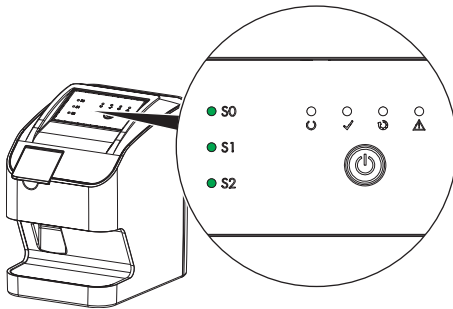

- › Open the cover.

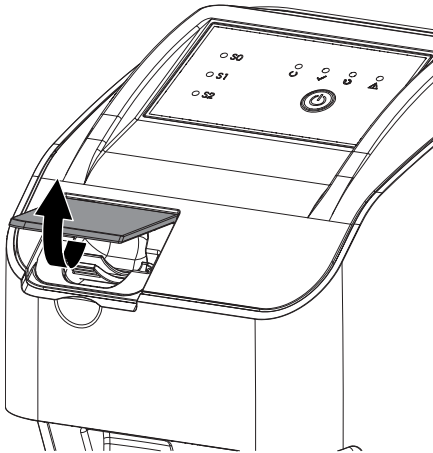

- › Remove cartridge.

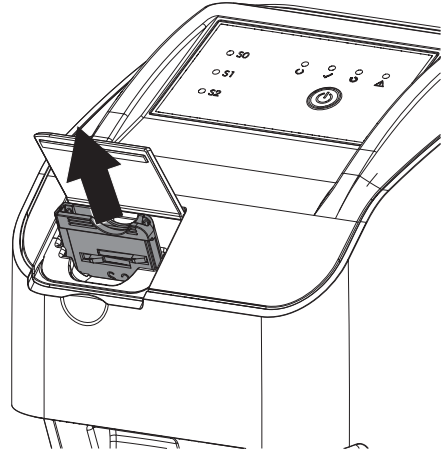

The green status LED flashes. The green cartridge display extinguishes.

- › Insert the appropriate cartridge.

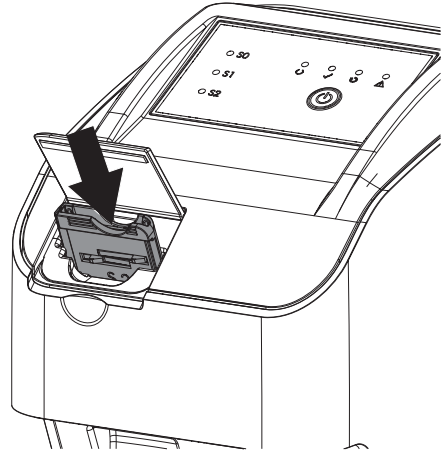

The green status LED lights up. The green display for the corresponding cartridge lights up.
The input unit is ready.

10.2 X-ray



The procedure is described using a size 2 PSP as an example.

Required accessories:

- PSP
- Barrier envelope of the same size as the PSP

WARNING
Risk of cross contamination when not using the barrier envelope or when using the barrier envelope more than once

- › Do not use an phosphor storage plate without a barrier envelope.
- › Do not re-use the barrier envelope (disposable item).

WARNING
Danger from the re-use of products intended for single use

- Single-use article is damaged after use and cannot be reused.
- › Dispose of single-use articles after use.

Preparing the X-ray

- ✓ The PSP has been cleaned.
- ✓ The PSP is not damaged.
- ✓ RFID tag sticks to the phosphor storage plate.
 If the RFID tag peels off, replace the phosphor storage plate.
- › During first use or after storage for over a week: erase the PSP (see "10.4 Erasing the imaging plate").
- › Completely slide the PSP into the barrier envelope. The white (inactive) side of the PSP must be visible.

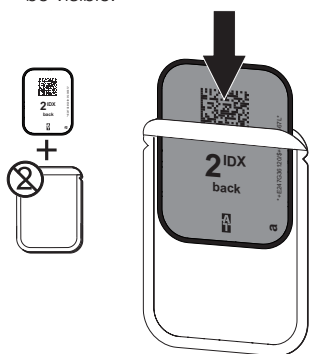

- › Pull off the adhesive strip and close the barrier envelope tightly by pressing together firmly.

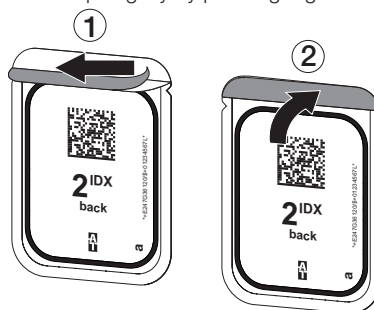

Taking the X-ray image

NOTICE
Damage to the phosphor storage plate (PSP) caused by a sharp-edged holding system

- › Only use holding systems that do not damage the barrier envelope or the PSP.
- › Do not use holding systems with sharp edges.



Wear hand protection.

- › Place the PSP in the barrier envelope into the patient's mouth.
 In doing this, make sure that the active side of the phosphor storage plate faces the X-ray tube.

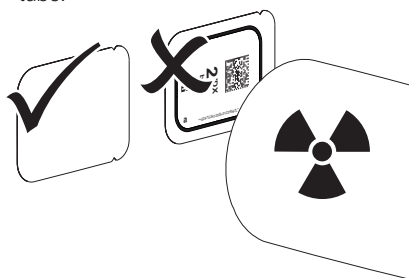

- › Set the exposure time and setting values on the X-ray unit (see "8.4 X-ray unit settings").
- › Record the X-ray image.
 The image data must be scanned within 30 minutes.

Preparing for scanning



CAUTION

Light erases the image data on the phosphor storage plate

- › Never handle exposed phosphor storage plates without the barrier envelope.



Wear hand protection.

- › Remove the PSP with the barrier envelope from the patient's mouth.



WARNING

Contamination of the unit

- › Clean and disinfect the barrier envelope before removing the PSP.
- › In the event of heavy soiling, e. g. from blood, dry clean the barrier envelope and protective gloves, e. g. wipe with a clean cellulose cloth.
- › Disinfect the barrier envelope and protective gloves with a suitable disinfection wipe; see "11.2 Barrier envelope".

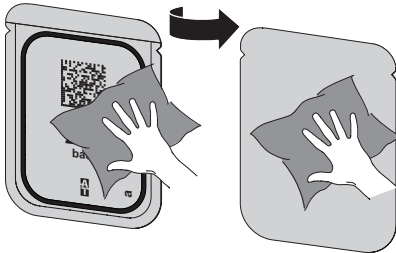

- › Allow the barrier envelope and phosphor storage plate to fully dry in a hygienic environment.
- › Take off the protective gloves and disinfect your hands.



NOTICE

Powder from the protective gloves on the PSP damages the unit during scanning

- › Completely clean all traces of the protective glove powder from your hands before handling the PSP.
- › Tear off the barrier envelope.



10.3 Scanning the image data

Starting the imaging plate scanner and software



The scanning process is described for the VisionX imaging software.

For further information regarding the use of the imaging software, refer to the relevant manual.

- › Press the on/off switch  to switch on the unit.
- › Switch on the computer and monitor.
- › Start VisionX.
- › Select the patient.
- › Select the corresponding acquisition type in the menu bar.
- › Select the unit.
- › Set the image mode.
Recording starts directly.

Result:

The green status LED lights up. Scan the phosphor storage plate at this point (and not before).

Scanning the PSP



In order not to mix up X-ray images, only scan the X-ray images from the selected patient.

- › Open the cover.

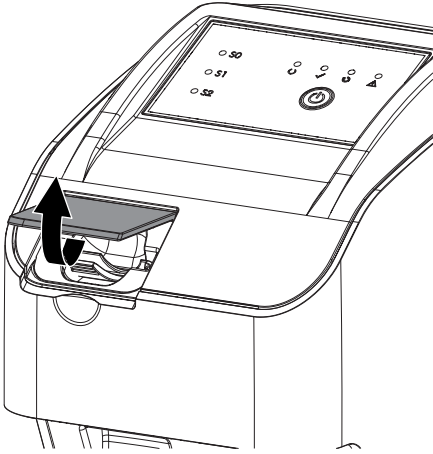

- › Place the barrier envelope with the PSP centrally and straight onto the input unit. The torn-off side of the barrier envelope faces down; the inactive (back) side of the phosphor storage plate faces the operator.

The phosphor storage plate must not be pulled out of the barrier envelope before placing it against the input unit. There is the risk of image information being erased by ambient light (see "9 Correct use of phosphor storage plates").

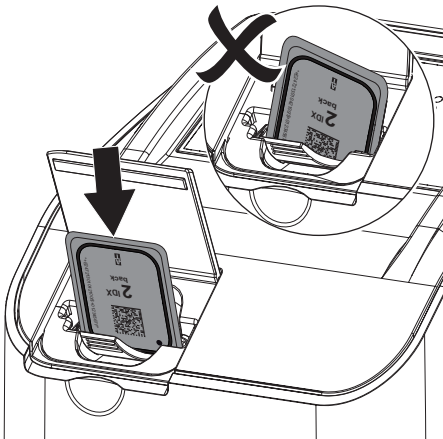

- › Slide the phosphor storage plate out of the barrier envelope downwards into the unit. The phosphor storage plate must be inserted fully into the input unit.

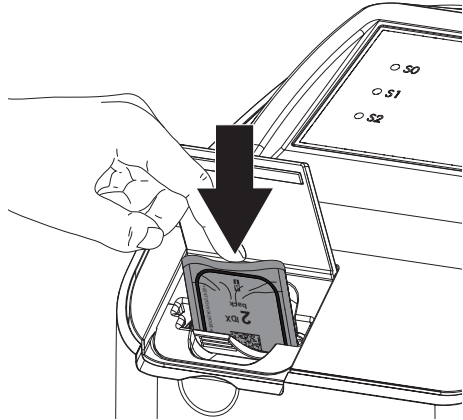

Make sure to insert only the phosphor storage plate, and not the barrier envelope, into the unit.

- › Remove the empty barrier envelope.

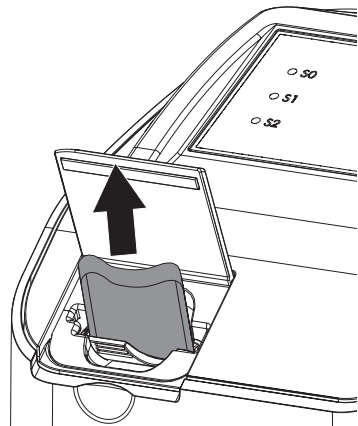

- › Once the phosphor storage plate has been inserted into the unit, close the cover and leave it closed throughout the entire scanning process.

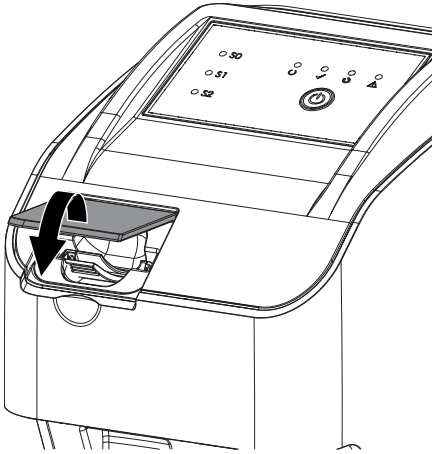

The blue status LED lights up.

The image data is automatically transmitted to the imaging software. The progress of the scanning process is displayed in the preview window on the monitor.

After it has been scanned, the PSP is erased and drops into the collection tray.

- › When the green status LED lights up:
Save the X-ray image.
- › Remove the PSP and prepare it for recording another X-ray image.

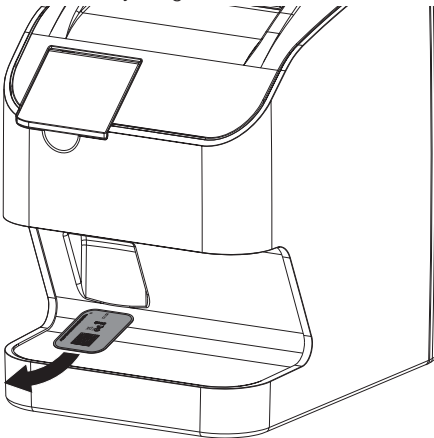

10.4 Erasing the imaging plate

The image data is erased automatically after scanning.

The special **ERASE** mode only activates the erasure unit of the image plate scanner. No image data is scanned.

The phosphor storage plate needs to be erased using the special mode in the following cases:

- The first time the phosphor storage plate is used or if it is stored for more than one week.
 - Due to an error, the image data on the phosphor storage plate has not been erased (software error message).
- › Select the special **ERASE** mode in the software.
 - › Insert the phosphor storage plate (see "Scanning the PSP").

10.5 Switching the unit off

- › Press the on/off switch  for 3 seconds.

As soon as the unit has shut down it switches off completely. The LEDs go out.

11 Cleaning and disinfection

When cleaning and disinfecting the unit and its accessories, comply with national directives, standards and specifications for medical products as well as the specific specifications for dental practices or clinics.



NOTICE

The use of unsuitable agents and methods can damage the unit and accessories

- › Only use the disinfection and cleaning agents specified or approved by Air Techniques and the EPA.
- › Comply with the operating instructions of the disinfectants and cleaning agents.



Wear hand protection.

11.1 Imaging plate scanner

Surface of the unit

The surface of the unit must be cleaned and disinfected if it is contaminated or soiled.



NOTICE

Liquid can cause damage to the unit

- › Do not spray the unit with cleaning agents or disinfectants.
- › Make sure that liquid penetrates into the unit.

- › Remove any soiling with a soft, lint-free cloth that has been dampened with cold tap water.
- › Disinfect the surfaces with a disinfection wipe. Alternatively, use a spray disinfectant on a soft, lint-free cloth. Comply with the operating instructions of the disinfectant.

Cartridges (S0-S2)

The cartridges can be cleaned and disinfected by wipe disinfection.



NOTICE

Heat damages the cartridge

- › Do not subject the unit to steam sterilization.

- › Remove any soiling from both sides of the cartridge with a dampened, soft, lint-free cloth.

- › Disinfect the cartridge with a disinfection wipe. Alternatively, use a spray disinfectant on a soft, lint-free cloth. Comply with the operating instructions of the disinfectant.
- › Allow the cartridge to completely dry before use.

11.2 Barrier envelope

- › Clean the Barrier Envelope after being removed from the patient's mouth with a disinfectant wipe, such as Air Techniques Monarch Surface Wipes.
- › Allow the Barrier Envelope to completely dry prior to ejecting the PSP.

11.3 Phosphor storage plate

Cleaning and disinfection wipes are unsuitable for the cleaning of phosphor storage plates and may damage them.

Only use a cleaning agent that is compatible with the materials:

Air Techniques recommends the phosphor storage plate cleaning wipe (see "3.4 Consumables"). Only this product has been subjected to material compatibility testing by Air Techniques.



NOTICE

Heat or humidity damage the phosphor storage plate

- › Do not sterilize the phosphor storage plate with steam.
- › Do not disinfect the phosphor storage plate by immersion.
- › Only use cleaning agents that are compatible with the materials.

- › Soiling on both sides of the phosphor storage plate should be cleaned off with a soft, lint-free cloth before each use.
- › Remove persistent or dried soiling with the phosphor storage plate cleaning cloth. Comply with the instructions for use of the cleaning cloth.
- › Allow the phosphor storage plate to completely dry before using it.

12 Maintenance

12.1 Recommended maintenance schedule



Prior to working on the unit or in case of danger, disconnect it from the mains.

The recommended maintenance intervals are based on using the unit for 25 intraoral images per day and 220 working days per year.

Maintenance interval	Maintenance work
Annually	<ul style="list-style-type: none"> › Visually inspect the unit. › Check the PSPs for scratches and replace them, if necessary. › Remove dust and dirt from accessible parts. › Carry out a system check.
Every 3 years	<ul style="list-style-type: none"> › Exchange the cartridges.

12.2 Check image quality

To assure the image quality, the unit must be subjected to maintenance (see "12.1 Recommended maintenance schedule") and regular cleaning and disinfection (see "11 Cleaning and disinfection") and the image quality of the PSP and X-ray system need to be checked.

Inspection interval	Work
Daily / before each use	<ul style="list-style-type: none"> › Clean the PSP, if necessary. › Check the PSP for scratches. If there are scratches on the surface, take a homogeneous test image (see "Check the PSP with a homogeneous test image"), replace the PSP, if applicable. › Keep an eye on the image quality with each X-ray image taken, also refer to "13.1 Poor X-ray image".
Monthly	<ul style="list-style-type: none"> › Take a homogeneous test image of the PSP (refer to "Check the PSP with a homogeneous test image"). If scratches or artifacts are visible in the image that may possibly have an adverse effect on the diagnostics, replace the PSP.
Every 3 months	<ul style="list-style-type: none"> › Check X-ray system. › Take an X-ray image with a 2D X-ray test phantom. Check the image for homogeneity, resolution, contrast and artifacts, refer to "Check X-ray system".

Check the PSP with a homogeneous test image

Scratches on the surface of the PSP may be visible in the X-ray image and may impair the ability to diagnose the X-ray images. If scratches are visible in the image that may impair the diagnostics, the PSP must be discarded.

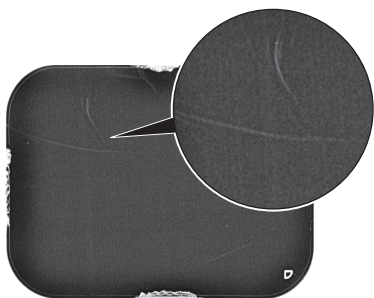

Fig. 4: PSP with scratches

- › Place the PSP on a level surface at a distance of approximately 30 cm from the X-ray tube. Doing this, make sure that the active side of the PSP faces the X-ray tube.
- › Set the exposure time and setting values on the X-ray unit for a molar x-ray image (see "8.4 X-ray unit settings").
- › Scan the PSP with the PSP scanner at high resolution.
- › Check the image for homogeneity.
 - No scratches visible in the image: PSP can still be used.
 - Scratch is visible in the image: discard the PSP.

Check X-ray system

To check the X-ray system, take an X-ray image with the 2D X-ray test phantom (refer to "3.3 Optional items"). This can be used to check the image produced with the X-ray system for homogeneity, resolution, contrast and artifacts.

- › Take an X-ray image with the 2D X-ray test phantom. Comply with the instructions for use of the test body.
- › Read the PSP.
- › Check the image for homogeneity, resolution, contrast and artifacts.
- › If errors are visible in the image, contact a service technician.

? Troubleshooting



13 Tips for operators and service technicians

 Any repairs above and beyond routine maintenance may only be done by suitably qualified personnel or by one of our service technicians.

 Prior to working on the unit or in case of danger, disconnect it from the mains.

13.1 Poor X-ray image

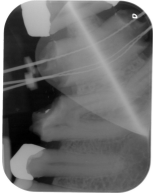
Error	Possible cause	Remedy
Instead of the X-ray image, the software shows a completely white image or no image	Phosphor storage plate not fed in straight and inactive side was scanned	➤ Scan the phosphor storage plate again immediately, protecting it against ambient light and making sure you feed it in correctly in the process.
	Image data on the PSP has been erased, e.g. by ambient light	➤ Always scan the image data of the PSP as soon as possible.
	Fault in the unit	➤ Contact technician.
	No image data on phosphor storage plate, phosphor storage plate not exposed or not sufficiently exposed	➤ X-ray tube / check settings of the unit ➤ Expose the PSP.
	X-ray unit is faulty	➤ Contact technician.
	Incorrect cartridge, barrier envelope was also pushed into the unit	➤ Use the correct cartridge for the size of phosphor storage plate being used.
Phosphor storage plate falls out of the unit and no image appears on the monitor	IDX phosphor storage plate was not used	➤ Only use Air Techniques IDX phosphor storage plates.
X-ray image too dark	X-ray dose too high	➤ Check X-ray parameters.
	Incorrect brightness/contrast settings in the software	➤ Adjust the brightness of the X-ray image in the software.
X-ray image too bright	Exposed PSP has been exposed to ambient light	➤ Always scan the image data of the PSP as soon as possible.
	X-ray dose too low	➤ Check X-ray parameters.
	Incorrect brightness/contrast settings in the software	➤ Adjust the brightness of the X-ray image in the software.
X-ray image only shadowy	The X-ray dose on the phosphor storage plate was insufficient	➤ Increase X-ray dose.
	Amplification (HV value) is set too low in the software	➤ Increase amplification (HV value).

Error	Possible cause	Remedy
<p>Ghosting or double exposure on X-ray image</p> 	<p>Unsuitable scanning mode selected</p> <p>PSP exposed twice</p> <p>PSP not sufficiently erased</p>	<ul style="list-style-type: none"> ➤ Select a suitable scanning mode. ➤ Only expose the PSP once. ➤ Check the erasure unit for proper function. ➤ Inform a service technician, if the problem persists.
<p>X-ray image mirrored in one corner</p> 	<p>PSP creased during X-ray exposure</p>	<ul style="list-style-type: none"> ➤ Do not bend the PSP.
<p>Shadow on the X-ray image</p> 	<p>PSP removed from the barrier envelope before scanning</p>	<ul style="list-style-type: none"> ➤ Do not handle PSPs without a barrier envelope. ➤ Store the PSP in a barrier envelope.
<p>X-ray image cut off, part missing</p> 	<p>A metal part of the X-ray tube is in front of the X-ray beam</p>	<ul style="list-style-type: none"> ➤ Recording an X-ray image, make sure there are no metal parts between the X-ray tube and the patient. ➤ Check X-ray tube.
<p>Software unable to combine the data to make a complete image</p>	<p>The X-ray dose on the PSP was insufficient</p> <p>Amplification (HV value) is set too low in the software</p> <p>Unsuitable scanning mode selected</p>	<ul style="list-style-type: none"> ➤ Increase X-ray dose. ➤ Increase amplification (HV value). ➤ Select a suitable scanning mode.

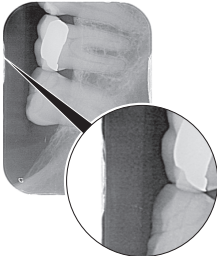
Error	Possible cause	Remedy
<p>X-ray image has stripes on image</p> 	<p>The setting for the threshold value is too high</p> <hr/> <p>Phosphor storage plate has been pre-exposed, e.g. by natural radiation or stray X-ray radiation</p> <hr/> <p>Parts of phosphor storage plate exposed to light during handling</p> <hr/> <p>Phosphor storage plate dirty or scratched</p> <hr/> <p>Unit was shaken by impact or cover of the input unit closed during scanning process</p>	<p>➤ Reduce the threshold value.</p> <hr/> <p>➤ If the phosphor storage plate has been stored for more than one week, erase the phosphor storage plate prior to use.</p> <hr/> <p>➤ Do not expose exposed phosphor storage plates to bright light.</p> <p>➤ Scan image data within half an hour after the exposure.</p> <hr/> <p>➤ Clean the phosphor storage plate.</p> <p>➤ Replace scratched phosphor storage plate.</p> <hr/> <p>➤ Set up the unit so that it cannot be shaken.</p> <p>➤ Prevent the unit from being touched during the scanning process.</p>
<p>Bright stripes in the scanning window</p>	<p>Too much incident ambient light during the scanning process</p>	<p>➤ Darken the room.</p> <p>➤ Turn the unit such that no light is directly incident on the input unit.</p>
<p>X-ray image with small bright spots or clouding</p>	<p>Micro scratches on the PSP</p>	<p>➤ Replace the PSP.</p>
<p>Lamination of the PSP detaches at the edge</p> 	<p>Wrong retainer system used</p> <hr/> <p>PSP handled incorrectly.</p>	<p>➤ Only use original PSP and film retainer systems.</p> <hr/> <p>➤ Use the PSP correctly.</p> <p>➤ Comply with the operating instructions of the PSP and film retainer systems.</p>

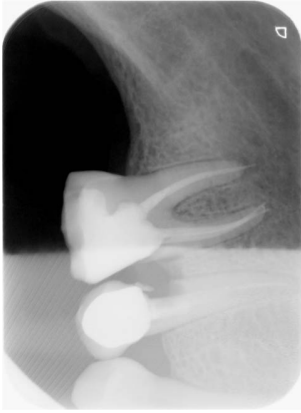
Error	Possible cause	Remedy
<p>The X-ray image shows a pre- erasure at one end</p> 	<p>After the barrier envelope has been torn open, the image plate is pushed out of barrier envelope prior to scanning.</p>	<ul style="list-style-type: none"> ➤ Do not push out the phosphor storage plate until the torn-off barrier envelope has been placed on the input unit.

13.2 Software error

Error	Possible cause	Remedy
<p>"Too much ambient light"</p>	<p>Unit is exposed to too much light</p>	<ul style="list-style-type: none"> ➤ Darken the room. ➤ Turn the unit such that no light can directly enter into the entry slot.
<p>"Overtemperature"</p>	<p>Laser or erasure unit too hot</p>	<ul style="list-style-type: none"> ➤ Switch the unit off and allow it to cool.
<p>"Erasure unit fault"</p>	<p>LED defective</p>	<ul style="list-style-type: none"> ➤ Contact technician.
<p>Imaging software fails to recognize the unit</p>	<p>Unit not switched on</p>	<ul style="list-style-type: none"> ➤ Switch the device on.
	<p>Connecting cable between unit and computer not correctly connected</p>	<ul style="list-style-type: none"> ➤ Check the connecting cable.
	<p>Computer does not detect any connection to the unit</p>	<ul style="list-style-type: none"> ➤ Check the connecting cable. ➤ Check the network settings (IP address and subnet mask).
	<p>Hardware error The IP address of the unit is being used by another unit</p>	<ul style="list-style-type: none"> ➤ Contact technician. ➤ Check the network settings (IP address and subnet mask) and assign a unique IP address to each unit. ➤ Inform a service technician, if the problem persists.

Error	Possible cause	Remedy
Error message "E2490"	The connection to the unit was interrupted while the software was still attempting to communicate with the unit	<ul style="list-style-type: none"> ➤ Restore the connection to the unit. ➤ Repeat the process.
Error during data transmission between unit and computer. Error message "CRC error timeout"	Connecting cable used is incorrect or too long	<ul style="list-style-type: none"> ➤ Only use original cables.
Software message: "VisionX has detected that the phosphor storage plate may have been exposed from the wrong side. Please check the orientation and the image quality before making a diagnosis"	The phosphor storage plate was exposed on the back (inactive) side while the X-ray was being taken	<ul style="list-style-type: none"> ➤ When diagnosing the X-ray image, note that the X-ray image is displayed mirror-inverted.

13.3 Fault on the unit

Error	Possible cause	Remedy
Unit not shown in the imaging software	Network cable not plugged in	<ul style="list-style-type: none"> ➤ Plug-in the network cable.
	No DHCP server connected	<ul style="list-style-type: none"> ➤ It may take some time for the imaging software to detect the unit. ➤ Update the unit list.
	Faulty network configuration	<ul style="list-style-type: none"> ➤ Configure the network correctly.
Unit does not switch on	No mains voltage	<ul style="list-style-type: none"> ➤ Check the mains cable and plug connection and replace if necessary. ➤ Check the power supply unit. ➤ If the green status LED does not light up, replace the power supply unit. ➤ Check the mains fuse in the building.
	On/off switch is defective	<ul style="list-style-type: none"> ➤ Contact technician.
Unit switches off again after a short time	Mains cable or power supply unit plug not inserted correctly	<ul style="list-style-type: none"> ➤ Check the mains cable and plug connections.
	Hardware defect	<ul style="list-style-type: none"> ➤ Contact technician.
	Mains supply voltage too low	<ul style="list-style-type: none"> ➤ Check the mains supply voltage.
Unit is on but none of the indicator LEDs light up (status, error or operating LEDs)	Display defective	<ul style="list-style-type: none"> ➤ Contact technician.

Error	Possible cause	Remedy
Unit not responding	The unit has not yet completed the startup procedure	➤ After switching the unit on, wait 20 - 30 seconds for the startup procedure to be completed.
	Unit is blocked by the firewall	➤ Enable the ports for the unit in the firewall settings.
Phosphor storage plate does not fit into the intake slot	Incorrect cartridge used	➤ Use the correct cartridge for the size of phosphor storage plate being used.
Barrier envelope slips into intake slot along with the phosphor storage plate	Incorrect cartridge used (too large)	➤ Use the correct cartridge for the size of phosphor storage plate being used.
Cartridge display does not light up	Cartridge not inserted correctly	➤ Insert the cartridge correctly.
Network connection has been disconnected	Connecting cable between unit and computer not correctly connected	➤ Check the connecting cable.
	The IP address of the unit is in use by another unit	➤ Check the network settings (IP address and subnet mask) and assign a unique IP address to each unit. ➤ Inform a service technician, if the problem persists.
Unit ejects the phosphor storage plate without the image data being transmitted to the imaging software. Error message: "Incorrect phosphor storage plate type inserted"	IDX phosphor storage plate was not used	➤ Only use Air Techniques IDX phosphor storage plates. ➤ The ejected phosphor storage plate can be imported on a suitable phosphor storage plate scanner (e.g. ScanX Swift View). Make sure that the phosphor storage plate is protected against ambient light.

14 Scanning times

The scanning time is the time required for complete scanning of image data and depends on PSP format and pixel size.

The time to image depends mainly on the computer system used and its work load. Times stated are approximate.

For technical reasons, the surface of the largest size of phosphor storage plate (size 2) is always scanned. As a result, the scan times are the same for all sizes of phosphor storage plate.

Max. theoretical resolution (LP/mm)	16.7	10
Pixel size (µm)	30	50
Intra Size 0 (2 x 3) to Intra Size 2 (3 x 4)	20 s	13 s

15 File sizes (uncompressed)

The file sizes depend on the PSP format and the pixel size. File sizes stated are approximate and have been rounded upwards.

Suitable compression methods can considerably reduce the file size without loss of data.

Max. theoretical resolution (LP/mm)	16.7	10
Pixel size (µm)	30	50
Intra Size 0 (2 x 3)	1.8 MB	1.1 MB
Intra Size 1 (2 x 4)	2.3 MB	1.4 MB
Intra Size 2 (3 x 4)	3.0 MB	1.8 MB

16 Handover record

This document confirms that a qualified handover of the medical device has taken place and that appropriate instructions have been provided for it. This must be carried out by a qualified adviser for the medical device, who will instruct you in the proper handling and operation of the medical device.

Product name	Order number (REF)	Serial number (SN)

- Visual inspection of the packaging for any damage
- Unpacking the medical device and checking for damage
- Confirmation of the completeness of the delivery
- Instruction in the proper handling and operation of the medical device based on the operating instructions

Notes:

Name of person receiving instruction:

Signature:

Name and address of the qualified adviser for the medical device:

Date of handover:

Signature of the qualified adviser for the medical device:

--	--



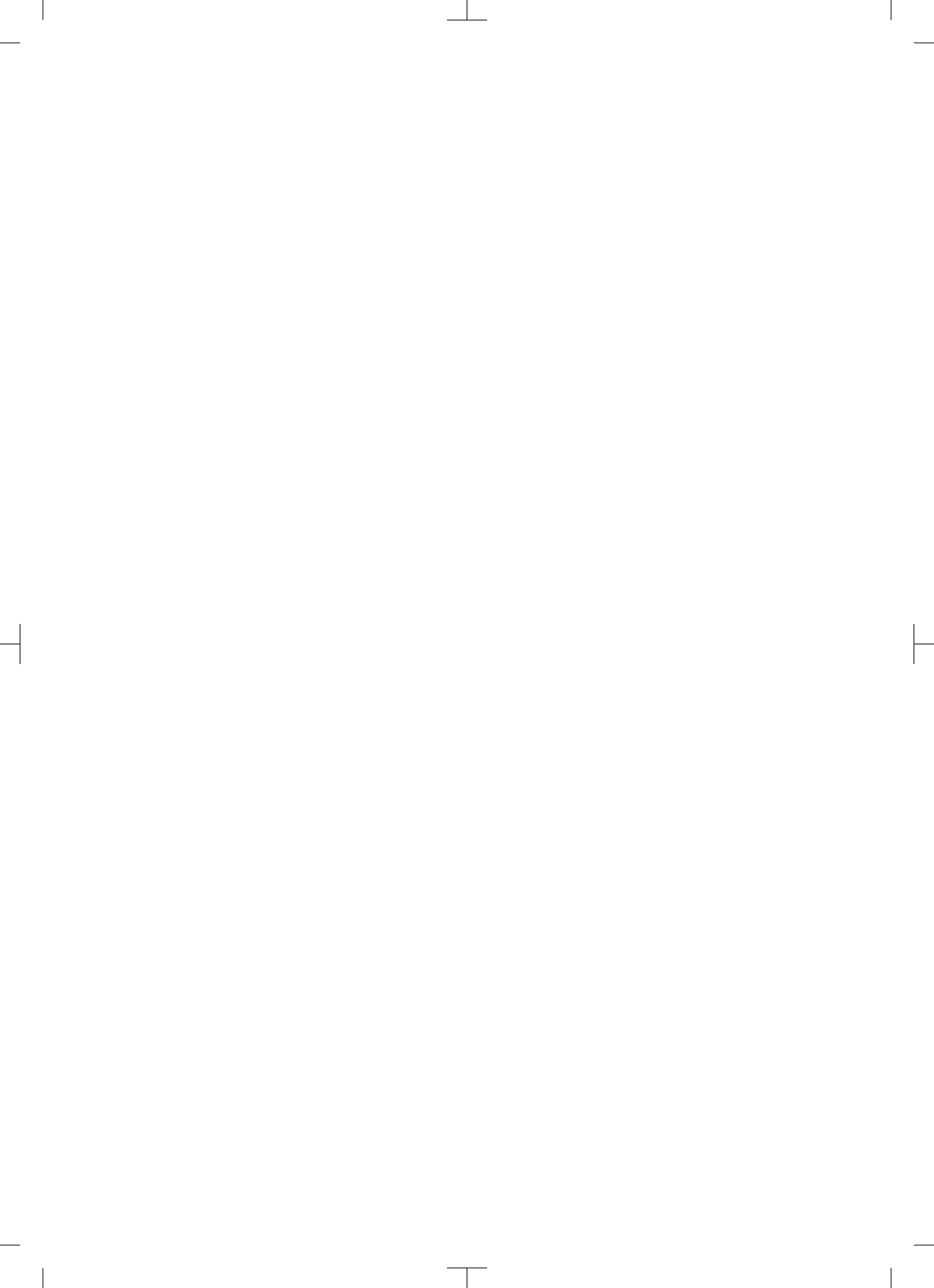

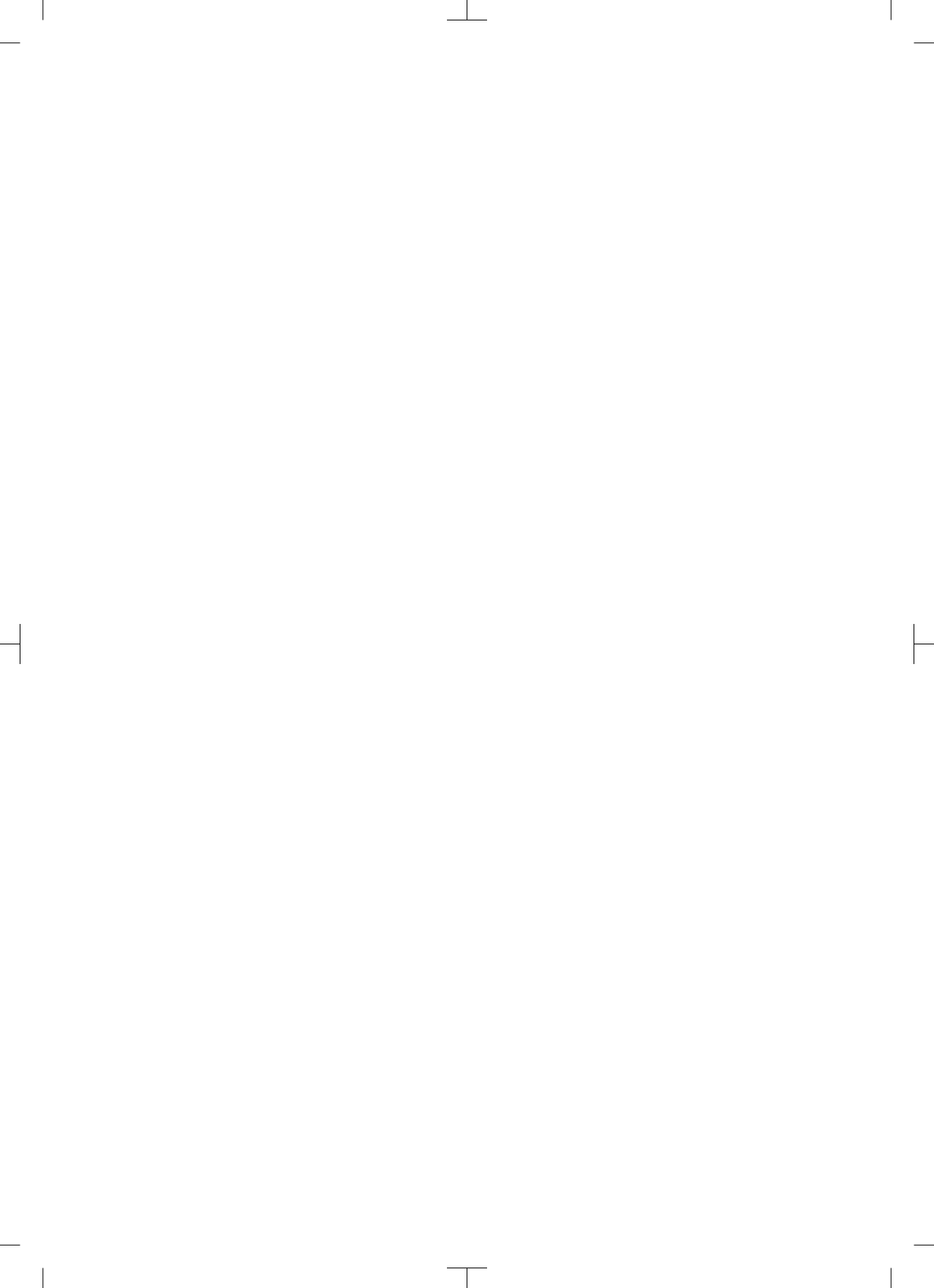

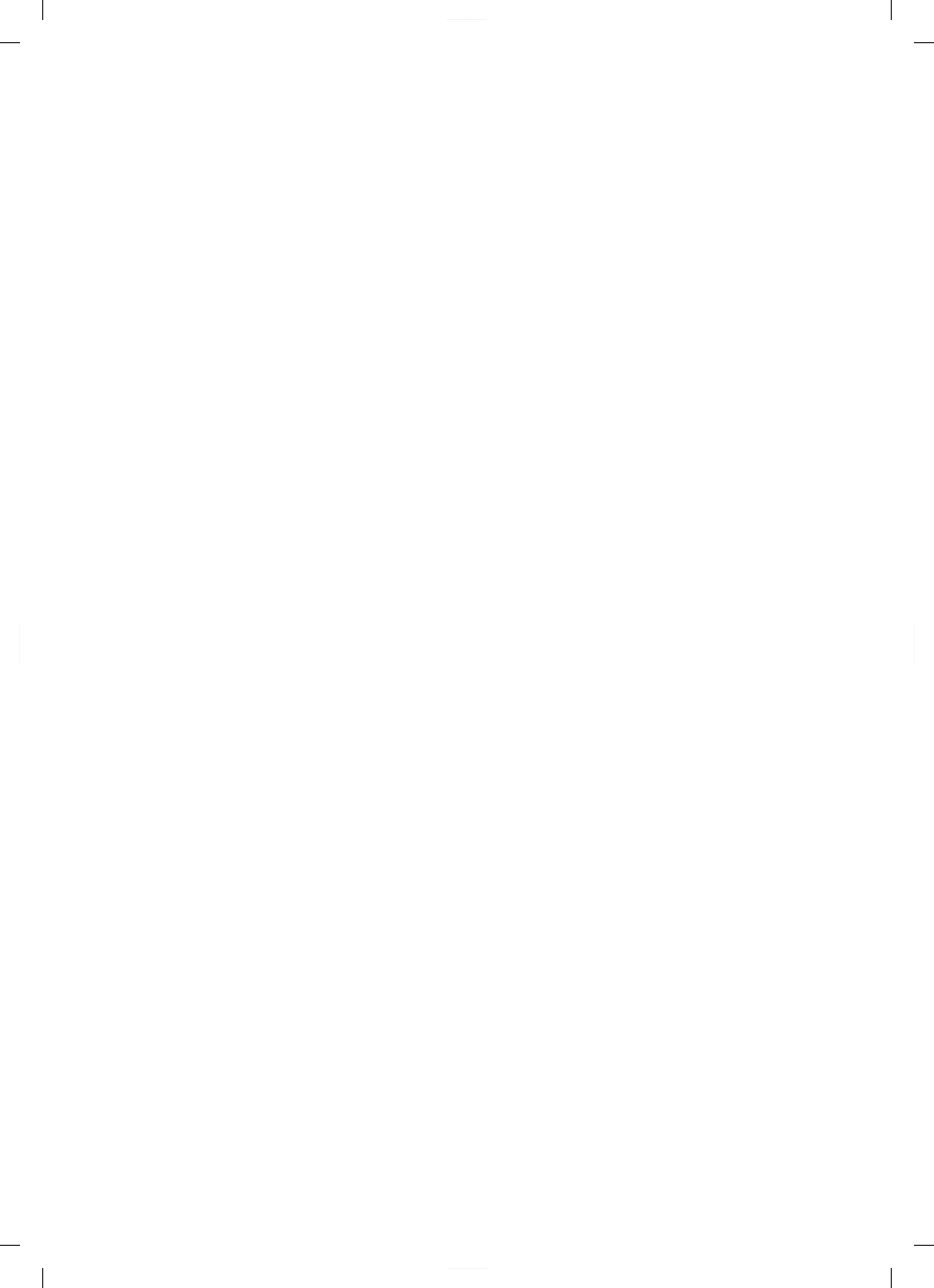

For over 50 years, Air Techniques has been a leading innovator and manufacturer of dental products. Our priority is ensuring complete satisfaction by manufacturing reliable products and providing excellent customer and technical support. Whether the need is digital imaging, utility room equipment or merchandise, Air Techniques can provide the solution via our network of authorized professional dealers.

Air Techniques' family of quality products for the dental professional include:

- **Digital Imaging**
 - Digital Radiography
 - Intraoral Cameras
 - Caries Detection Aid
 - X-ray Systems
 - Film Processors
- **Utility Room**
 - Dry Vacuums
 - Wet Vacuums
 - Air Compressors
 - Amalgam Separator
 - Utility Accessories
 - Utility Packages
- **Merchandise**
 - Imaging Accessories
 - Chemistry
 - Processor Cleaners
 - Surface Disinfectant
 - Instrument Cleaner
 - Hand Sanitizer + Hand Lotion
 - Evacuation System Cleaner
 - Water Line Cleaner

Manufactured for / Distributed by:

Air Techniques, Inc. | 1295 Walt Whitman Road | Melville, New York 11747-3062, USA
Phone: 800-247-8324 | Fax: 888-247-8481



DÜRR DENTAL SE | Höpfigheimer Str. 17 | 74321 Bietigheim-Bissingen | Germany

www.airtechniques.com



**AIR
TECHNIQUES** equipped for life®